



Funded by the European Union
بتمويل من الاتحاد الأوروبي

School Construction Programme (SCP)
Funded by the European Union, through the EU Regional Trust
Fund in response to the Syrian crisis, the EU Madad Fund



EUTF Support to Construct 10 Schools in Jordan

EU No.: - TF-MADAD/2018/T04.112

BMZ No.: 3020 00131

Environmental and Social Impact Assessment (ESIA) and Environmental and Social Management Plan (ESMP) Report

**School No.: 25- Hai Al Sharqi Secondary Mixed School
(Amman Governorate)**

EU Component - Regular Track

Employer: Ministry of Public Works and Housing

Date of issue: 28 January 2021 | FINAL

Prepared by: Joint Venture SCP lead by Dorsch International Consultants GmbH

KFW



Version	Prepared by	Reviewed by	Approved by	Date
01	Saba' Alhamarneh Environmental Engineer	Dr. Dirk Matzke Environmental Expert	Luis Palmeira Senior Programme Manager	24.March 2020
02	Saba' Alhamarneh Environmental Engineer	Dr. Dirk Matzke Environmental Expert	Salam Najjar Senior Programme Manager	28. January 2021

Approval on Final Version Only:

MoPWH Signature:

MoE Signature:

TABLE OF CONTENT

1. INTRODUCTION	1
1.1. PROJECT BACKGROUND	1
1.2. SITE SELECTION APPROACH	1
2. OBJECTIVES OF ESIA ASSESSMENT REPORT AND SITE SELECTION	2
2.1. OBJECTIVES OF THE ASSESSMENT REPORT	2
2.2. SELECTED PROJECT LOCATION HAI AL SHARQI SECONDARY MIXED SCHOOL	2
3. LEGISLATIVE AND INSTITUTIONAL FRAMEWORK.....	5
3.1. KFW SUSTAINABILITY GUIDELINE	5
3.2. DONOR SAFEGUARD REQUIREMENTS AND APPLICABLE STANDARDS	5
3.2.1. EU Environmental and Social Standards.....	5
3.2.2. World Bank Environmental and Social Standards	6
3.2.3. Core Labour Standards (CLS) of the International Labour Organization.....	7
3.3. RELEVANT NATIONAL LEGISLATIVE AND REGULATORY FRAMEWORK	7
3.4. GAP ANALYSIS.....	12
4. ASSESSMENT PROCESS.....	13
4.1. INITIAL ENVIRONMENT EXAMINATION (IEE)	13
4.2. RESULTS OF SITE VISIT – 28 TH AUGUST 2019	13
4.3. RESULTS OF SITE VISIT – 11 TH MARCH 2020.....	13
4.4. INITIAL STAKEHOLDER PARTICIPATION.....	14
5. ENVIRONMENTAL AND SOCIAL BASELINE CONDITIONS	16
5.1. PHYSICAL ENVIRONMENT	16
5.1.1. Soil.....	16
5.1.2. Land Use.....	17
5.1.3. Noise and Vibrations	17
5.1.4. Water Resources	17
5.1.5. Air Quality	21
5.1.6. Road Access & Traffic.....	21
5.2. SOCIO-ECONOMIC ENVIRONMENT	22
5.2.1. Catchment Area	22
5.2.2. Access to Medical, Communal and Religious Services	24
5.2.3. Small Scale Business.....	25
5.2.4. Overview of Demographic Profile	25
5.3. BIOLOGICAL ENVIRONMENT	25
6. IMPACT IDENTIFICATION AND ANALYSIS.....	27
6.1. EXPECTED ENVIRONMENT AND SOCIAL IMPACTS.....	27
6.2. IMPACT SIGNIFICANCE ASSESSMENT.....	27
6.3. PROPOSED TOPICS TO BE SCOPED OUT.....	28

6.4.	IMPACT CATEGORISATION.....	29
7.	ENVIRONMENTAL AND SOCIAL MANAGEMENT PLAN.....	37
7.1.	CONTRACTORS, ENGINEERS AND EMPLOYER ROLES AND RESPONSIBILITIES.....	37
7.2.	ENVIRONMENTAL AND SOCIAL MITIGATION DURING CONSTRUCTION & OPERATION	39
7.3.	ENVIRONMENTAL AND SOCIAL MONITORING DURING CONSTRUCTION & OPERATION	48
8.	STAKEHOLDER ENGAGEMENT PLAN	60
8.1.	GRIEVANCE MECHANISM FOR THE CONCERNED PUBLIC	60
8.2.	GRIEVANCE MECHANISM FOR WORKERS	62
8.3.	MONITORING OF STAKEHOLDER ENGAGEMENT PLAN	63

LIST OF ANNEXES

ANNEX 1:	OFFICIAL LETTER OF MOENV. REGARDING EIA PROCEDURES
ANNEX 2:	INITIAL ENVIRONMENTAL EXAMINATION (IEE) PROTOCOLS
ANNEX 3:	PUBLIC CONSULTATION PROTOCOL
ANNEX 4:	PUBLIC CONSULTATION QUESTIONNAIRE

LIST OF FIGURES

Figure 2-1: Overview Map Locating Hai Al Sharqi Site in Amman Governorate	3
Figure 2-2: Location Map Hai Al Sharqi Site.....	4
Figure 5-1: Soil Orders and Great Groups in Jordan	16
Figure 5-2: Schematic of Water Supply in Sahab – System One	18
Figure 5-3: Schematic of Water Supply in Sahab – System Two	18
Figure 5-4: Surface Water Basins in Jordan	19
Figure 5-5: Groundwater Basins in Jordan	20
Figure 5-6: Road Access to School Site No. 25 Hai Al Sharqi Secondary Mixed School	21
Figure 5-7: Aerial View Showing Empty Part of the Plot and Roads.....	22
Figure 5-8: Details of Schools Located Within the Catchment Area of the School Site No.25.....	23
Figure 5-9: Catchment Area of School No.25 Hai Sharqi Secondary Mixed School. 24	
Figure 5-10: Location of Closest Mosque to Hai Al Sharqi Site	24
Figure 5-11: Location of Proposed Site in Relation to Protected Areas	26
Figure 8-1: Proposed Grievance Mechanism Procedure	62

LIST OF TABLES

Table 4-1: List of Concerned Stakeholders.....	15
Table 5-1: Main Features of Surface Water Basins	19
Table 5-2: Safe and Actual Yields for Ground Water Basins in Jordan	20
Table 5-3: Population Statistics of Al Abdalieh Neighbourhood.....	25
Table 6-1: Classification of Impacts.....	28
Table 6-2: Summary of Environmental and Socio-economic Impacts During Construction Phase	33
Table 6-3: Summary of Environmental and Socio-economic Impacts During Operation Phase.....	36
Table 7-1: Environmental and Social Mitigation Measures During Construction Phase	46

Table 7-2: Environmental and Social Mitigation Measures During Operation Phase	47
Table 7-3: Environmental and Social Monitoring During Construction.....	56
Table 7-4: Environmental and Social Monitoring During Operation	59

LIST OF ABBREVIATIONS

BMZ	Federal Ministry of Economic Cooperation and Development
CDD	Civil Defence Department
CESMP	Contractor's Environmental and Social Management Plan
CLS	Core Labour Standards
CO	Carbon Monoxide
CO ₂	Carbon Dioxide
Consultant	Dorsch International Consultants GmbH in Joint Venture with AHT Group AG and DAR AL OMRAN Planning, Architecture and Engineering
DLS	Department of Land and Survey
DoA	Department of Antiquities
DoE	Directorate of Education
DoS	Department of Statistics
E&S	Environment & Social
EHS	Environmental Health and Safety
ESHS	Environmental, Social, Health and Safety
ESIA	Environmental and Social Impact Assessment
ESMP	Environmental and Social Management Plan
ESS	Environmental and Social Standards
EU	European Union
GIIP	Good International Industrial Practices
HS	Health and Safety
IBA	Important Bird Areas
IEE	Initial Environmental Examination
(I)FC	(International) Financial Cooperation
ILO	International Labour Organization
JRP	Jordan Response Plan
KfW	KfW Development Bank
km	Kilometer (= 1,000 m)
m	Meter
MoA	Ministry of Agriculture
MoE	Ministry of Education
MoEnv	Ministry of Environment
MoH	Ministry of Health
MoL	Ministry of Labour
MoLA	Ministry of Local Administration
MoPIC	Ministry of Planning and International Cooperation
MoPWH	Ministry of Public Works and Housing

MSDS	Material Safety Data Sheets
MWI	Ministry of Water and Irrigation
NGO	Non-Governmental Organization
NOx	Nitrogen Oxides
PEA	Project Executing Agency
PIA	Project Implementing Agency
PM	Particulate Matter
PPE	Personal Protective Equipment
SCP	School Construction Programme
SEP	Stakeholder Engagement Plan
SOx	Sulphur Oxides
SSR	Site Selection Report

1. INTRODUCTION

1.1. Project Background

In general, Jordan has a functional educational system, with an infrastructure that is characterized by quantitative and qualitative bottlenecks. The high number of refugees as a consequence of the Syria crisis poses additional strain on the educational system. Overcrowding and double shifts have led to worsened learning conditions and decreased educational quality, leading to political and social tensions among different population groups in Jordan. The consequences are low personal and economic development perspectives for the emerging generation. The need for additional schooling capacities has been outlined by the Jordanian Government within the Jordan Response Plan (JRP) to the Syria crisis.

The main target group of the programme are Jordanian and Syrian children living in communities with a particularly high share of vulnerable Jordanian children as well as of Syrian refugees.

Therefore, the Schools Construction Program (SCP) is to improve learning conditions in the field of basic education in the target areas depending on the site selection process through the provision and adequate utilization of additional school infrastructure and the corresponding equipment.

In order to support the Jordanian government in addressing such challenges, the Government of Germany, represented through BMZ, and the European Union have planned to provide funds for the construction, extension and equipment of public basic schools in Jordan, including associated consulting services, and the construction and the equipping of ten new schools in Jordan and the financing of related accompanying measures, respectively. Therefore, the SCP will be implemented by the KfW Development Bank and will cover two main components:

Component 1: FC Component funded by the German Government through KfW which comprises the projects “School Construction Programme I (BMZ No. 2016 68 334)” and “School Construction Programme II (BMZ No. 2016 68 938)”

Component 2: EU Component funded by the European Union (EU) through KfW, which encompasses the construction of 10 new schools and Complementary Measures

The ultimate beneficiary will be the Hashemite Kingdom of Jordan, represented by the Ministry of Planning and International Cooperation (MoPIC), which will channel the funds to Ministry of Public Works and Housing (MoPWH) (construction works) and Ministry of Education (MoE) (furniture and equipment) respectively. Hence, MoPIC has signed the Financing Agreement with KfW. Both MoE and MoPWH have signed the Separate Agreement to the Financing Agreement. MoPWH shall act as Project Executing Agency (PEA), while MoE shall be the Project Implementing Agency (PIA).

1.2. Site Selection Approach

Under the framework of the SCP, the MoE (PIA) shall provide the MoPWH (PEA), with a Master List of 50 recommended sites to be considered as potential for new school projects or school expansion projects. The Consultant shall carry out a site selection process to the existing list to determine a shortlist of 10 new schools to be constructed under the EU Component and up to 13 new/expanded schools under the FC Component.

In the Site Selection Report (SSR) – Volume 5, the Consultant recommends the construction of a basic mixed school instead of a secondary school which would ease the pressure of overcrowded schools in the catchment area.

This report follows the approved structure assessment and addresses Hai Al Sharqi Secondary Mixed School (School No. 25 of the Master List), proposed under the SSR (Summary and Recommendations) under the EU Component and received approval by MoE, consent by MoPWH and no objection by KfW.

2. OBJECTIVES OF ESIA ASSESSMENT REPORT AND SITE SELECTION

2.1. Objectives of the Assessment Report

The implementation of the SCP may have the potential to cause environmental and/or social impacts that shall be addressed in accordance to relevant Jordanian legislations as well as the requirements of the KfW Development Bank Sustainability Guidelines of 2019, the EU Environmental and Social (E&S) Standards, the World Bank Environmental and Social Standards and those of the International Labour Organisation (ILO). Chapter 3 provides more details on the applicable legislative framework for the SCP.

The environmental clearances and permits are governed by the Ministry of Environment (MoEnv), under the stipulations of the Environmental Impact Assessment No. (37) of 2005. Based on consultations with the Licensing Department of the (MoEnv) in May 2019, it has been officially confirmed that the scope of this project does not require the involvement of MoEnv (response letter of MoEnv to MoPWH dated 29 May 2019 saved as **Annex 1**).

This report covers the environmental and social assessment for Hai Al Sharqi site located in Amman Governorate. The objective of the report is to provide an Environmental and Social Assessment in order to identify important environmental and socio-economic issues arising from the proposed works, especially prior and during construction of the proposed school and to prepare a corresponding Environmental & Social Management Plan (ESMP).

In accordance to the above, the following structure has been followed in this ESIA Assessment Report:

- Chapter 1: provides a general overview of the Program, its components, expected service and beneficiaries
- Chapter 2: this chapter provides a description objective of this ESIA Assessment Report and its structure
- Chapter 3: provides a description of the applicable local and international Legislative and Institutional Framework
- Chapter 4: provides a description of the Assessment process implemented for this project site
- Chapter 5 provides a description of the Environmental and Social Baseline Conditions
- Chapter 6: presents the identification of impacts and its related analysis
- Chapter 7: presents the corresponding Environmental and Social Management Plan (ESMP) as well as the related Monitoring Plan
- Chapter 8: Stakeholder Engagement Plan (SEP)

2.2. Selected Project Location Hai Al Sharqi Secondary Mixed School

The proposed Hai Al Sharqi site is located in Sahab district within Amman Governorate as shown in Figure 2-1. It will be designed to include 13 classrooms, providing up to 570 new places for students including 2 kindergarten classes of 50 students. This will solve the problems of overcrowding in girls' schools and ease the pressure off the crowded basic boys' school. Further details are provided in Section 5.2.1.

The site allocated for the construction of the school is made up of one plot: No. 38 in basin No. 4 with an overall area of 11,380 m² as shown in Figure 2-2, around 4,000 m³ of the total area will be allocated to the construction of the proposed school. Acquisition of plot is pending and according to the directorate, an official letter has been sent and awaiting full allocation to the MoE. The land is shared with an existing basic mixed school and a sports field, leaving 4,000 m² for the proposed school.

The entire plot is accessible through one main road with no dangerous highways around it. The site is located in a residential area with an adjacent basic mixed school. The plot is served by all utility networks except sewage network. In this regard, the school will utilize septic tanks during construction and operation to collect wastewater generated to be transported to the closest Wastewater Treatment Plant.

The closest Mosque is Aisha Um Al Mo'meenen Mosque which is around 800 m of the plot. Medical and communal service facilities are also located nearby. No industrial activities take place within the Project area; moreover, typical small-scale business activities are almost absent.

The site has been visited and inspected and is found to comply with most of the major physical/technical criteria. Further baseline analysis of the site is presented in Chapter 5.

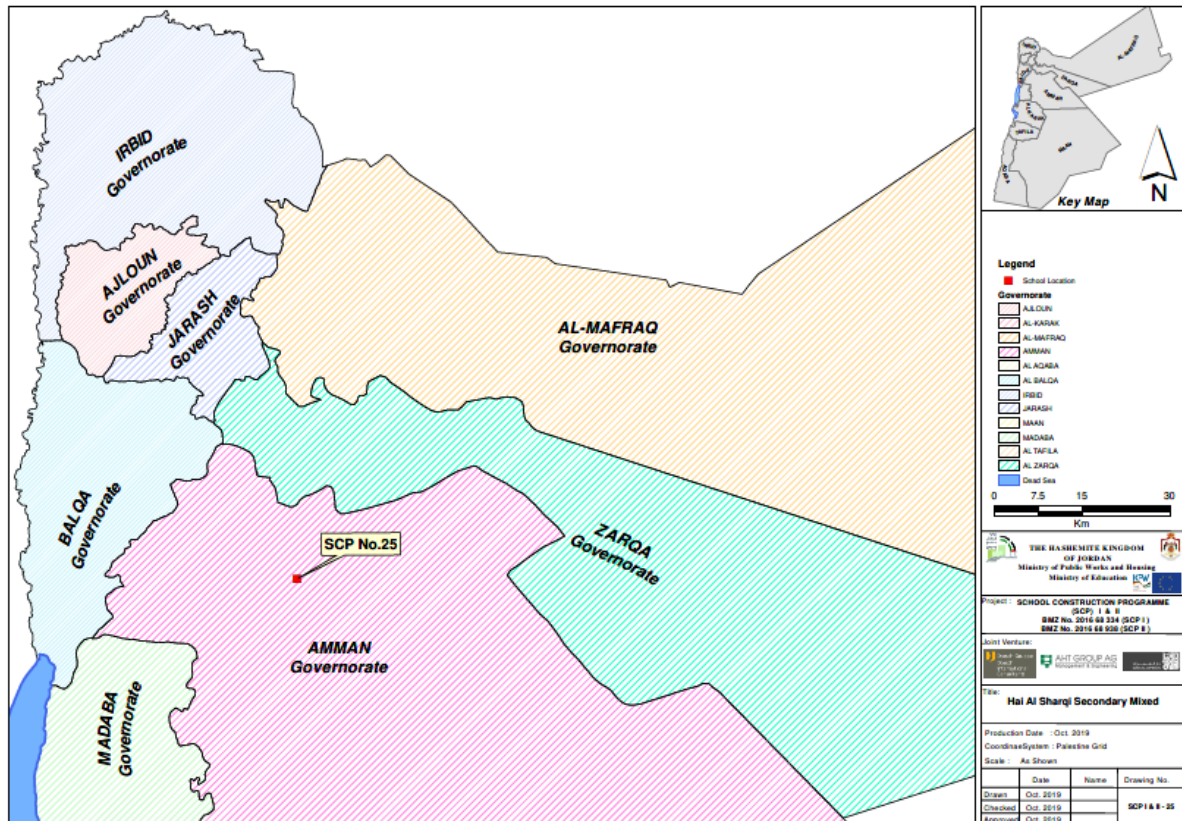

Figure 2-1: Overview Map Locating Hai Al Sharqi Site in Amman Governorate

Source: Consultant, School Selection Report Vol 5 Final, March 2020



Figure 2-2: Location Map Hai Al Sharqi Site

Source: Department of Land and Survey, DLS, 2020



Figure 2-3: Panoramic View of Hai Al Sharqi Site

Source: Consultant, site visit, March 2020

3. LEGISLATIVE AND INSTITUTIONAL FRAMEWORK

This section addresses the legislative and institutional framework relating to ESIA development, specifically relevant to the SCP and the environmental and social impact assessment associated with this type of projects. For this project the ESIA (here ESIA Assessment Report) has been prepared under specific consideration of the:

- Sustainability Guideline of KfW Development Bank,
- EU Environmental and Social Standards
- World Bank Environmental and Social Standards, and
- Core labour standards of the International Labour Organisation (ILO).

The national framework considers environmental laws and regulations of the Government of the Hashemite Kingdom of Jordan, in particular, the Environmental Protection Law No.6 last amended in the year 2017.

Based on consultations with the Licensing Department of the (MoEnv) in May 2019, it has been officially confirmed that the scope of this project does not require the involvement of MoEnv (response letter of MoEnv to MoPWH dated 29 May 2019 saved as Annex 1).

3.1. KfW Sustainability Guideline

With the aim of sustainability and avoiding adverse environmental, social and climate impacts and risks, KfW Development Bank policy requires consideration of corresponding sustainability principles in Financial Cooperation (FC) measures that are financed.

In this context, the appropriate consideration of environmental and social requirements in proposed projects prior to the start of the services is crucial. The guiding document is the KfW Sustainability Guideline last amended in the year 2019. In accordance with the KfW Sustainability Guideline FC measures are categorised as A to C depending on their potential of environmental and social impacts or risks.

Moreover, in the light of the COVID-19 pandemic, KfW Development Bank issued an Info-Sheet in April 2020 on Preventing and Managing related Environmental, Social, Health and Safety (ESHS) risks as a guidance document aiming to minimize the risks caused by the virus in the development finance context especially with regards to social topics and occupational health and safety. It is addressed to project executing agencies, implementation consultants, EPC contractors, project's developer, private equity funds and financial institutions and includes namely recommendations on managing risks, communications with both employees and stakeholders, retrenchment, dealing with worker camps, etc.

With regard to the School Construction Programme in order to comply with the provisions of the KfW Sustainability Guideline under the legislative framework described earlier, the Consultant has undertaken a two-step procedure. The first step is the preparation of an Initial Environmental Examination during field trips to the concerned site followed by the more detailed development of an ESIA Assessment Report. Reference is made to Chapter 4.

3.2. Donor Safeguard Requirements and Applicable Standards

3.2.1. EU Environmental and Social Standards

The Environmental legislations of the EU are considered to be greatly intertwined with various international and national environmental policies that address vital issues across the environmental and social spectrum. These extensive policies aim to protect natural habitats, keeping the air and water clean, ensure sound waste disposal, as well as promoting a sustainable economy.

Given that the KfW Sustainability Guidelines (2019) refer to the EU Environmental and Social Standards, the EU Environmental Impact Assessment Directive 2011/92/EU and its latest

amendments 2014/52/EU is the main governing legislation which can govern the preparation of this ESIA Assessment Report.

In accordance to Annexes I and II, the activities planned under the SCP do not fall under either classification, therefore as mentioned in the Directive, Member States may determine whether the project shall be made subject to an assessment, based on either a case-by-case examination or thresholds or criteria set out by Member States. As described previously, the Jordanian legislations do not require the preparation of the EIA for this project.

Following an equal approach as the KfW Sustainability Guideline this ESIA Assessment Report is complying with the stipulations of the EIA Directives 2011/92/EU & 2014/52/EU, here Articles 5 – 10.

3.2.2. World Bank Environmental and Social Standards

Under the World Bank's Environmental and Social Framework issued in 2017, ten (10) Environmental and Social Standards (ESS) have been identified to outline the requirements for the "Borrower" relating to the to the identification and assessment of environmental and social risks and impacts associated with projects supported by the Bank through Investment Project Financing. Such standards will support the "Borrower" in achieving good international practices within the scope of environmental and social sustainability; fulfil national and international E&S obligations; promote non-discrimination, transparency, participation, accountability and governance, and enhance sustainable development outcomes of projects through ongoing stakeholder engagement.

In general, there are ten (10) ESS; subject to consideration or exclusion (scope out) to the SCP:

- ESS 1: Assessment and Management of Environmental and Social Risks and Impacts
- ESS 2: Labour and Working Conditions
- ESS 3: Resource Efficiency and Pollution Prevention and Management
- ESS 4: Community Health and Safety
- ESS 5: Land Acquisition, Restrictions on Land Use and Involuntary Resettlement
- ESS 6: Biodiversity Conservation and Sustainable Management of Living Natural Resources
- ESS 7: Indigenous Peoples/Sub-Saharan African Historically Underserved Traditional Local Communities
- ESS 8: Cultural Heritage
- ESS 9: Financial Intermediaries
- ESS 10: Stakeholder Engagement and Information Disclosure

Given the initial analysis and applicability of the above-mentioned standards, ESS 7 and ESS 9 are not applicable based on the following justifications.

ESS 7 "*Indigenous Peoples/Sub-Saharan African Historically Underserved Traditional Local Communities*" is not applicable, as there are no such groups or communities within the project site area nor are such groups affected by the Project.

ESS 9 "Financial Intermediaries" is not applicable, as there are no FIs involved in this Project.

Environmental and social issues considered as not relevant to the SCP are assessed and scoped out during the impact identification and analysis process (Chapter 6).

General Environmental Health and Safety (EHS) Guidelines

The General EHS Guidelines developed by the International Finance Corporation (IFC), cover a wide range of technical references that can be applied to general and industry-specific actions that resonate with Good international Industry Practices (GIIP). These Guidelines can be applicable to this program, along with the mentioned legislations outlined in this chapter. Specifically, the following EHS guidelines can be considered:

- General EHS Guideline (1): Environmental
- General EHS Guideline (2): Occupational Health and Safety
- General EHS Guideline (3): Community Health and Safety
- General EHS Guidelines (4): Construction and Decommissioning

3.2.3. Core Labour Standards (CLS) of the International Labour Organization

The International Labour Organization (ILO) is a tripartite organization consisting of trade unions, governments and companies, and is part of the United Nations system. In 1998, the ILO produced the Declaration on Fundamental Principles and Rights at Work. In the Declaration, ILO member states agreed that they should all respect, promote, and realize Core Labour Standards (whether or not they have ratified them).

The core labour standards consist of four standards, laid out in eight conventions:

- Freedom of association and the effective recognition of the right to collective bargaining (Convention No. 87 & No. 98).
- The elimination of all forms of forced and compulsory labour (Convention No. 29 & No. 105).
- The effective abolition of child labour (Convention No. 138 & No. 182).
- The elimination of discrimination in respect of employment and occupation (Convention No. 100 & No. 111).

Today all International Financing Institutions including KfW have fully adopted CLS in their activities. In contrast Jordan has not ratified ILO Convention No. 87 (Freedom of Association and Protection of the Right to Organize Convention), one of the eight fundamental conventions.

Responding adequately to this situation the Consultant will assess whether the project has to establish any provisions in order to bridge any gaps resulting from non-ratification of the convention.

3.3. Relevant National Legislative and Regulatory Framework

This section outlines the Jordanian Legislative and Regulatory framework relevant to this project. The legislations of various authorities must be taken into consideration to ensure an all-inclusive understanding of the specific requirements and obligations.

The legislations listed below have been tailored to apply the anticipated activities of this project to guarantee the protection of social, health and environmental aspects; where specific stipulations and clauses may apply in reference to the scope of this Programme.

- **Laws:**

- Environmental Protection Law No. 6 of 2017

This Law aims at highlighting the responsibilities of the Ministry of Environment (MoEnv) as the responsible entity for ensuring the protection of the environment including aspects such as Air, Noise, Biodiversity, Community Health and Safety, and other receptors from the impacts of various projects. The MoEnv is also responsible for issuing licenses and approving ESIA studies prior to the establishment of facilities and/or projects.

- Municipalities Law No. 41 of 2015

This Law stipulates the responsibilities of Municipalities and relevant councils towards developing and implementing programs that ensure sustainable development throughout the Kingdom. Given the coordination between various entities, the main municipality services include solid waste management, manage water supply, preventing pollution, monitoring sanitation systems as well as public transport

- Labour Law No. 8 of 1966 and its amendments

The Labour Law was issued to guarantee the rights employers, employees and the government in terms of employment conditions, working hours, wages, health and safety requirements and all related Labour management issues. The Ministry of Labour (MoL) also issued various regulations and instructions that can be considered relevant under the Labour Law.

- Agricultural Law No. 13 of 2015

This Law aims to outline the obligations of the Ministry of Agriculture and its obligations towards combating desertification and conserving biodiversity in the Kingdom. The Ministry also issued various regulations that can be considered relevant under this Law.

- Water Authority Law No. 18 of 1988 and its amendments

This Law, issued by the Ministry of Water and Irrigation (MWI), and its amendments includes the responsibility the Ministry undertakes to protect all water resources of the country, by considering that all surface and groundwater sources are state-owned, and must be handled according to the stipulations of this Law and other relevant regulations, standards and instructions.

- Public Health Law No. 47 of 2008

The Law, issued by the Ministry of Health (MoH), prohibits health nuisance and identifies it as disposing or emptying the content of septic tanks in un-allocated places, medical wastes, liquid, solid or gaseous wastes, or nuisances that affect public health or cause a disturbance of public comfort.

- Antiquities Law No. 21 of 1988 and its amendments (No. 23 of 2004)

This Law issued by the Department of Antiquities (DoA) highlights the responsibilities of the Department including the obligation of issuing excavation permits for any site in the Kingdom; whereas, the Department has the sole right to carry out surveying or excavating of antiquities.

- Civil Defence Law No. 18 of 1999

This law states the responsibility of the Civil Defence Department (CDD) for its protection and ensuring the protection of citizens and the tasks to be performed in emergency cases. The CDD is a member of the National Jordanian Building Council, to hold the responsibility of approving various Jordanian national building codes.

- Jordanian National Building Law No. 7 of 1993 and its amendments (No. 24 of 2018)

This Law stipulates the responsibilities of the National Jordanian Building Council to ensure the compliance of all construction projects to National Building Codes that aim to ensure technical construction safety measures (i.e. firefighting systems code, warning systems code, fire prevention code and shelters code).

- Traffic Law No. 49 of 2008

This Law stipulates the responsibilities of the Traffic Department and the Public Security Department towards ensuring safe transportation within the Kingdom, including speed limits, licensing processes, vehicle conditions and its emissions of pollutants.

- Planning Cities, Towns, Villages and Building Law No. 79 of 1966 and its amendments

This Law, issued by the Ministry of Local Administration (MoLA), applies to all types of land uses and buildings and on any commercial establishments, when such lands and buildings fall within the current organized boundaries or are anticipated to fall within the boundaries.

- Acquisition Law No. 12 of the year 1987

The Law outlines the processes conducted for cases of land acquisition including advertising requirements, determination of fair compensations, and negotiation process with land owners, grievance and dispute procedures. It should be made clear that no land can be acquired unless it is for public benefit and that there is fair and transparent compensation procedure,

- **Regulations:**

- Environmental Impact Assessment Regulation No. 37 of 2005

This regulation outlines the requirements for conducting a comprehensive or preliminary Environmental Impact Study, depending on the type of projects being considered. The MoEnv is responsible for issuing such decisions, under their licensing department.

- Land Use Planning Regulation No. 6 of 2007

This regulation applies to areas that are not considered within the land use planning boundaries, outlined by the MoLa, which are categorised based on several criteria outlined in the official Land Use Map approved by the Council of Ministers.

- Regulation of Planning Cities, Towns, Villages and Building No. 136 of 2016 and its amendments (No. 13 of 2019)

This regulation applies to land plots, buildings, and construction projects on regulated areas in the Kingdom in addition to any legal person/entity, except for regulated areas having their own specific regulations. Specifically, this regulation allows the construction of schools in residential areas.

- Soil Protection Regulation No. 25 for 2005

The MoEnv in cooperation with any other competent entity shall set the required instructions for the protection of Soil from harmful effects of industrial dust, solid waste and solid and liquid industrial waste

The MoEnv and MoA and other competent entity will monitor the source of soil pollution and control them.

- Solid Waste Management Regulation No. 27 of 2005

This MoEnv highlights the duties and responsibilities of entities towards sound solid waste management practices including qualified workforce, equipment and machines for the management of the solid waste, in addition to monitoring the collection of such wastes.

- Management, Transportation & Handling of Harmful & Hazardous Substances Regulation No. 24 of 2005

This regulation outlines the tasks that an entity must comply with when dealing with harmful and hazardous substances

- Groundwater Control Regulation No. 85 of 2002 and its amendments

This regulation mainly highlights the responsibility of the owner/occupier/contractor of a certain project site to inform the Authorities for any case of groundwater resurfacing during construction work.

- Regulation for Categorizing Wild Birds and Animals Banded from Hunting No. 43 of 2008

This regulation lists the species that should not be hunted at any circumstances.

- Air Protection Regulation No. 28 of 2005

This regulation outlines the obligations that facilities must comply with to guarantee that there are no emissions or leakages of air pollutants at a level that exceeds the maximum allowable limit according to technical standards.

- Nuisance Prevention Regulation No. 68 of 2016

This regulation describes the mandates that must be implemented by any facility to prevent any public health nuisances resulting from improper management and disposal of waste streams.

- Regulation of Protection and Safety from Industrial tools and Machines and Work Sites No. 43 of 1998 and its amendments

This regulation describes the precautionary measures that must be undertaken to ensure safety in the work environment depending on the scope of work, by considering mechanical and electrical risks.

- Formation of Committees and Supervisors of Occupational Health and Safety Regulation No. 7 of 1998

This regulation outlines the requirements for the formation of committees within an establishment of a workforce exceeding 50 employees. Such committees are responsible for ensuring suitable occupational health and safety precautions are implemented, in addition to any procedures relevant to accidents and injuries.

- Regulation for Preventive and Curative Health Care for Workers in Establishments No. 4 of 1998 and its amendments

This regulation stipulates the requirement of ensuring the employee's good health and fitness throughout the employment.

- Regulation for the Fees of Work Permits for Non – Jordanians No. 36 of 1997 and its amendments

This regulation outlines the responsibilities and fees for issuing work permits for non-Jordanians depending on the industry and duration of stay.

- Regulation for Obligatory Employment of Jordanian Workforce from Surrounding Communities in Development Projects No. (131) for the year 2016

Indicates the required number whereby Jordanian technicians, workers and recent graduates must be appointed based on varying financial values of the specific tender. The regulation dictates that contractors, engineering offices, foreign companies, executing contractors must implement the provisions of this regulation for all projects beginning from the official effective date of the regulation.

- Regulation of Buildings and Planning of Cities and Villages No. 136 of 2016 and its amendments (No. 13 of 2019)

This regulation outlines the provisions of construction projects in cities and villages throughout the Kingdom. Whereby a Higher Regulatory Council is responsible for organizing and approving any residential, governmental, or investment project based on the stipulations of this regulation.

- **Instructions:**

- Instruction for Management and Handling of Consumed Oils for 2003

This instruction outlines the prohibited disposal method of consumed oils, and outlines the conditions related to the health and safety of individuals working with such oils; indicating the PPEs should be provided.

- Instruction for Hazardous Waste Management for 2003

The Instruction, developed by the MoEnv, lists general procedures to be carried out by the producer of hazardous wastes, procedures related to the gathering and storage of hazardous waste, emergency procedures plan, record-keeping and reporting, and general precautionary measures to be taken for packing hazardous waste.

- Instruction for Reduction and Prevention of Noise for 2003

This instruction outlines the minimum noise levels allowed in residential areas of villages, in addition to prohibiting construction activities between 8:00pm till 6:00am; exceptions are made for after attaining an approval by MoEnv.

– Instructions for Allowable Speed Limits for 2002

The Instruction states allowable speed limits for vehicles with reference to their weight and the type of road.

– Instructions for the Protection of Workers against Risks of the Work Environment

This instruction provides the requirement activities that must be implemented in the work site to ensure the protection of the workforce, including required PPEs, proper resting areas, acceptable noise level limits at the workplace, in addition to the requirement of performing hearing tests for employees.

• **Standards:**

– Ambient Air Quality Standard (JS 1140 – 2006)

This Jordanian standard provides technical requirements and allowable limits for air pollutants in terms of ambient air quality.

– General Precautionary Requirements for Storage of Hazardous Materials (JS 431 – 1985)

This Standard describes the general requirements to be abided by for the proper storage and handling of hazardous substances, in addition to prohibiting unauthorized entry to such storage facilities.

• **Guidelines**

In April 2020, with reference to the COVID-19 pandemic, the Government of Jordan issued a comprehensive guide covering the work procedures related to health and safety to reduce the spread of the Corona virus. This guide includes the general health and safety practices and standard operating procedures before and during work for the different sectors. On a more specific note, the Ministry of Labour issued a separate and detailed guide for working procedures applicable to construction sites covering health and safety prevention measures to reduce the Corona Virus pandemic (Guide No.12)¹. This guide includes general practices in the work place, provision of health and safety protection equipment, transportation of good and transportation. The latter is addressed in another specific guide covering the safety precautions and actions to reduce and control the Corona virus pandemic in the transportation sector (Guide No.11)².

¹ Ministry of Labour, “Guide 12: Working procedures for health and safety prevention measures to reduce Coronavirus outbreak in Construction sites”, April 2020

[http://www.mol.gov.jo/ebv4.0/root_storage/ar/eb_list_page/%D8%AF%D9%84%D9%8A%D9%84_12_-_D8%A7%D8%AC%D8%B1%D8%A7%D8%A1%D8%A7%D8%AA_%D8%A7%D9%84%D8%B9%D9%85%D9%84_%D9%84%D8%AA%D8%AF%D8%A7%D8%A8%D9%8A%D8%B1_%D8%A7%D9%84%D8%B3%D9%84%D8%A7%D9%85%D8%A9_%D9%88%D8%A7%D9%84%D9%88%D9%82%D8%A7%D9%8A%D8%A9_%D8%A7%D9%84%D8%B5%D8%AD%D9%8A%D8%A9_%D9%84%D9%84%D8%AD%D8%AF_%D9%85%D9%86_%D8%A7%D9%86%D8%AA%D8%B4%D8%A7%D8%B1_%D9%81%D8%A7%D9%8A%D8%B1%D9%88%D8%B3_%D8%A7%D9%84%D9%83%D9%88%D8%B1%D9%88%D9%86%D8%A7_\(%D8%A7%D9%84%D9%85%D8%B4%D8%A7%D8%B1%D9%8A%D8%B9_%D8%A7%D9%84%D8%A7%D9%86%D8%B4%D8%A7%D8%A6%D9%8A%D8%A9_\).pdf](http://www.mol.gov.jo/ebv4.0/root_storage/ar/eb_list_page/%D8%AF%D9%84%D9%8A%D9%84_12_-_D8%A7%D8%AC%D8%B1%D8%A7%D8%A1%D8%A7%D8%AA_%D8%A7%D9%84%D8%B9%D9%85%D9%84_%D9%84%D8%AA%D8%AF%D8%A7%D8%A8%D9%8A%D8%B1_%D8%A7%D9%84%D8%B3%D9%84%D8%A7%D9%85%D8%A9_%D9%88%D8%A7%D9%84%D9%88%D9%82%D8%A7%D9%8A%D8%A9_%D8%A7%D9%84%D8%B5%D8%AD%D9%8A%D8%A9_%D9%84%D9%84%D8%AD%D8%AF_%D9%85%D9%86_%D8%A7%D9%86%D8%AA%D8%B4%D8%A7%D8%B1_%D9%81%D8%A7%D9%8A%D8%B1%D9%88%D8%B3_%D8%A7%D9%84%D9%83%D9%88%D8%B1%D9%88%D9%86%D8%A7_(%D8%A7%D9%84%D9%85%D8%B4%D8%A7%D8%B1%D9%8A%D8%B9_%D8%A7%D9%84%D8%A7%D9%86%D8%B4%D8%A7%D8%A6%D9%8A%D8%A9_).pdf)

² Ministry of Labour, “Guide 11: Working procedures for health and safety prevention measures to reduce Coronavirus outbreak in the Transportation sector”, April 2020

[http://www.mol.gov.jo/ebv4.0/root_storage/ar/eb_list_page/%D8%AF%D9%84%D9%8A%D9%84_11_-_D8%A7%D8%AC%D8%B1%D8%A7%D8%A1%D8%A7%D8%AA_%D8%A7%D9%84%D8%B9%D9%85%D9%84_%D9%84%D8%AA%D8%AF%D8%A7%D8%A8%D9%8A%D8%B1_%D8%A7%D9%84%D8%B3%D9%84%D8%A7%D9%85%D8%A9_%D9%88%D8%A7%D9%84%D9%88%D9%82%D8%A7%D9%8A%D8%A9_%D8%A7%D9%84%D8%B5%D8%AD%D9%8A%D8%A9_%D9%84%D9%84%D8%AD%D8%AF_%D9%85%D9%86_%D8%A7%D9%86%D8%AA%D8%B4%D8%A7%D8%B1_%D9%81%D8%A7%D9%8A%D8%B1%D9%88%D8%B3_%D8%A7%D9%84%D9%83%D9%88%D8%B1%D9%88%D9%86%D8%A7_\(%D9%88%D8%B3%D8%A7%D8%A6%D8%B7_%D8%A7%D9%84%D9%86%D9%82%D9%84_\).pdf](http://www.mol.gov.jo/ebv4.0/root_storage/ar/eb_list_page/%D8%AF%D9%84%D9%8A%D9%84_11_-_D8%A7%D8%AC%D8%B1%D8%A7%D8%A1%D8%A7%D8%AA_%D8%A7%D9%84%D8%B9%D9%85%D9%84_%D9%84%D8%AA%D8%AF%D8%A7%D8%A8%D9%8A%D8%B1_%D8%A7%D9%84%D8%B3%D9%84%D8%A7%D9%85%D8%A9_%D9%88%D8%A7%D9%84%D9%88%D9%82%D8%A7%D9%8A%D8%A9_%D8%A7%D9%84%D8%B5%D8%AD%D9%8A%D8%A9_%D9%84%D9%84%D8%AD%D8%AF_%D9%85%D9%86_%D8%A7%D9%86%D8%AA%D8%B4%D8%A7%D8%B1_%D9%81%D8%A7%D9%8A%D8%B1%D9%88%D8%B3_%D8%A7%D9%84%D9%83%D9%88%D8%B1%D9%88%D9%86%D8%A7_(%D9%88%D8%B3%D8%A7%D8%A6%D8%B7_%D8%A7%D9%84%D9%86%D9%82%D9%84_).pdf)

3.4. Gap Analysis

In this previous chapters a comprehensive analysis of the legislative framework including the KfW Sustainability Guideline, donor safeguard requirements of the EU, World Bank and CLS, and also the relevant national provisions have been undertaken.

In this context, potential gaps among the Jordanian EIA requirements versus KfW sustainability requirements and ILO Convention No. 87 (Freedom of Association and Protection of the Right to Organize Convention) have been identified.

Considering that the ESIA can be condensed to mainly construction related issues, mitigating eventual gaps is the site engineer's obligation. Therefore, a further detailed gap analysis is considered as not required.

The identified gap with reference to ILO Convention No. 87 is addressed in Chapter 7 Environmental and Social Management Plan (Table 7-3) Environmental and social monitoring during construction).

4. ASSESSMENT PROCESS

In order to comply with the provisions of the KfW Sustainability Guideline and other international best practices and requirements under the legislative framework described in the preceding chapter, the Consultant has undertaken a two-step procedure. The first step is the preparation of an Initial Environmental Examination (IEE) based on site visits of qualified expert teams ('technical' team and 'E&S team') followed by the more detailed development of an impact identification and analysis (Chapter 6)

4.1. Initial Environment Examination (IEE)

The Consultant proposed to develop an IEE as a tool to initially review reasonably foreseeable impacts of a proposed activity to determine potential impacts. For the SCP an IEE template has been developed allowing a quick examination during site visits. Following the findings and outcomes of the initial site visits the IEE is forming the basis for the more detailed impact identification and analysis.

Usually, the identification and assessment of project impacts is based on the collection of qualitative and quantitative data describing the physical, socio-economic and biological environment, referred to as Environmental & Social Baseline Conditions (see Chapter 5). Given the fact that such data are difficult to acquire or even not available, here the IEE is providing a central function, even when collected data are subjective as based on visual observations and not considering any seasonal variation throughout the year.

For the proposed Hai Al Sharqi site two site visits applying IEE form have been executed. Key findings are summarised hereafter. The filled in IEE form is attached as **Annex 2**.

4.2. Results of Site Visit – 28th August 2019

The project team has conducted a site visit in August 2019, and has taken note of the following main observations:

- There is another school and a sports courtyard on the plot, leaving only 4,000 m² empty.
- There is a house that slightly trespasses onto the plot, however, the Directorate of Sahab has obtained a signed letter from the neighbor agreeing that he will remove the trespassing part once a project is planned for the land. This will be further verified upon conducting the topographic survey and finding will be reported to MoE for further action if necessary.
- Adjacent school was built through the Saudi Fund, Al Abdalieh Mixed Basic School, and overcrowding is reported by the Directorate.

Conclusion: The plot has passed the Preliminary Eligibility Criteria.

4.3. Results of Site Visit – 11th March 2020

The E&S team has conducted a further site visit in March 2020, and has taken note of the following main observations:

- In terms of E&S relevant factors (physical, socio-economic, biological) the visual site inspection has shown no or insignificant conflict potential.
- Potential negative impacts to nearby residents during the construction phase of the school can be effectively mitigated.
- Any business activities are concentrated along the main road and will not be negatively affected by the school construction.
- The site is not served by a sewage network.

- The access to site is not served by paved roads. However, there is a planned road which ends near the school edge. Discussions with municipality will be done to extend it to reach the eastern road
- The plot is shared with an existing basic mixed school and a sports field.

Conclusion: The proposed site can be considered as having no or minor impacts in accordance with the KfW Sustainability Guideline.

4.4. Initial Stakeholder Participation

Note: A generic Stakeholder Engagement Plan (SEP) has been prepared and is added as Chapter 8.

Both, Jordan legislation and regulations, but also the KfW Sustainability Guideline state clearly that public and stakeholder engagement is mandatory to give the opportunity to the public, stakeholders and surrounding community to express their opinion in the project and gain knowledge about the project. This may lead also to alter, modify the project design, location, etc. to consider the community needs and concerns.

During IEE site visits (one by 'technical' team, on by E&S team, see Chapter 4.1) representatives of concerned authorities have joined the project teams. These site visits have already provided important information about the perceptions of concerned stakeholders (**Table 4-1**).

To make sure that all concerned parties are involved a public consultation process a meeting will be organised by the Consultant. The outcomes and findings of the public consultation meeting will be integrated in the Environmental & Social Management Plan; the meeting protocol added as Annex to the final version of this ESIA Assessment report.

As an initial step towards preparing a Stakeholder Engagement Plan (SEP), the Consultant has analysed the relevant stakeholders to the project, who are considered to be affected or affect the project activities. The SEP shall be implemented during construction and operation phase of the project, where the Contractor and Operator are responsible for ensuring its proper implementation. Moreover, a Grievance Mechanism shall be put in place to allow the below mentioned stakeholders in communicating their concerns regarding any project activity.

Group of Stakeholders	Stakeholders	Level of involvement with the project
Local residents	<ul style="list-style-type: none"> • Residents located near the roads used for transporting materials or diversion of traffic 	Directly affected
Land owner	<ul style="list-style-type: none"> • Individuals, legal entities, local administration holding land title documents • Tenants or occupiers without formal rights 	Directly affected
Public facilities	<ul style="list-style-type: none"> • Educational facilities (kindergartens) • Religious entities (mosques) • Medical entities (hospitals, clinics, medical centre) • Utilities (electricity, water supply) 	Indirectly affected
Business and Service Providers	<ul style="list-style-type: none"> • Shops, markets, supermarkets • Petrol stations, car wash & service, others • Restaurants • Financial services (banks) 	Indirectly affected
Administrative Bodies and Authorities	<ul style="list-style-type: none"> • National Authorities <ul style="list-style-type: none"> - Ministry of Public Works and Housing (MoPWH) - Ministry of Education (MoE) - Ministry of Environment (MoEnv) - Water Authority of Jordan (WAJ) - Ministry of Antiquities • Regional authorities • Local authorities <ul style="list-style-type: none"> - Greater Amman Municipality 	Indirectly affected, but may have influence over the implementation of the project

Group of Stakeholders	Stakeholders	Level of involvement with the project
International donors	<ul style="list-style-type: none"> • KfW Development Bank • European Union 	Indirectly affected, but may have influence over the implementation of the project
Bodies involved in Project implementation	<ul style="list-style-type: none"> • Construction contractor(s) (management, staff) • Sub-contractor(s) • Supervision contractor (the Engineer) • Suppliers 	Directly affected, but may have influence over the implementation of the project
Non-Governmental Organizations (NGOs) and independent experts	<ul style="list-style-type: none"> • Specialized environmental, social and research organizations, NGOs • Experts on a national and international level 	Indirectly affected
Media	<ul style="list-style-type: none"> • Print media • Radio, TV • Internet sources 	Indirectly affected

Table 4-1: List of Concerned Stakeholders

Source: Consultant

5. ENVIRONMENTAL AND SOCIAL BASELINE CONDITIONS

This chapter describes the physical, socio-economic and biological baseline of the proposed site, based on the findings of the data collection, field investigations (here IEE) and review of the relevant documents.

5.1. Physical Environment

5.1.1. Soil

Amman Governorate is predominated by two soil orders; Inceptisols and Aridisols. Inceptisols are silty soils with high carbonate and low organic content; they exhibit a moderate degree of soil development and lack significant clay accumulation in the subsoil. Moreover, they are widely distributed and occur across a wide range of ecological settings, parent materials and climatic conditions, and thus have a wide range of characteristics.

Aridisols are soils with dry moisture regime and weak soil development. They contain subsurface horizons in which clays, calcium carbonate, silica, salts and/or gypsum have accumulated. The dry climate and low humus content limit their arability without irrigation.

The main great groups of soil in Amman Governorate are Haploxerepts (Xerochrept) under the Inceptisols order, Haplocalcids and Haplocambids (Calciorthids and Camborthids respectively) under the Aridisols order.

As shown in figure below, the soil in the proposed site for Hai Al Sharqi Secondary Mixed School is Haploxerepts (Xerochrept).

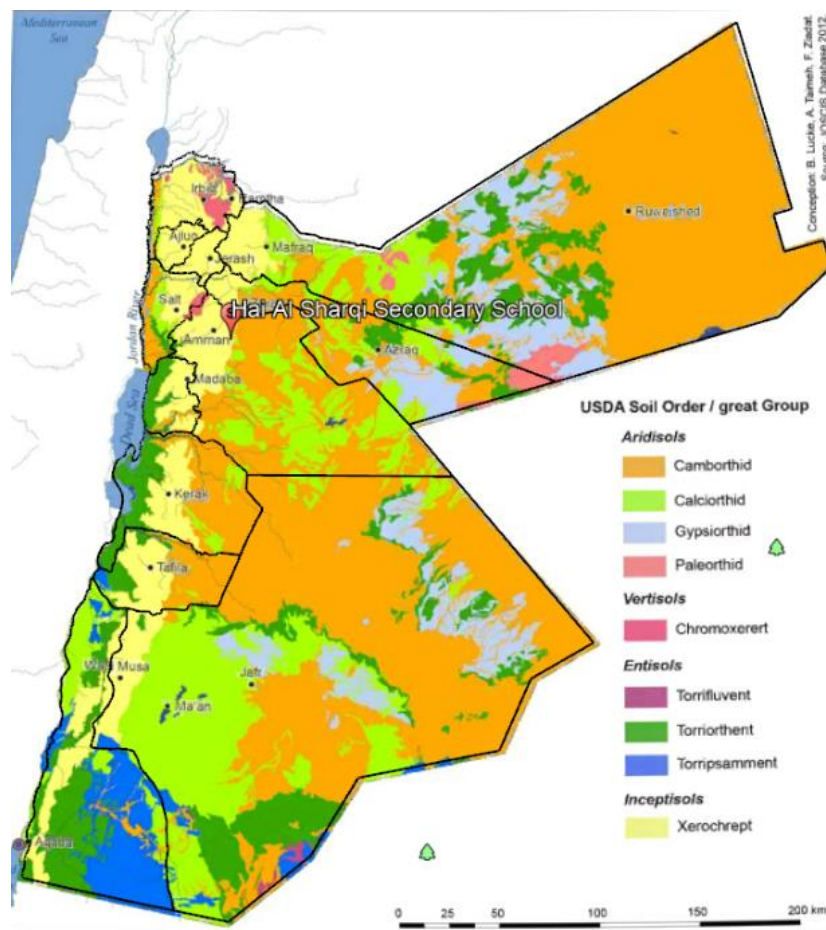

Figure 5-1: Soil Orders and Great Groups in Jordan

Source: Atlas of Jordan, 2013

5.1.2. Land Use

The plot has an area of 11,380 m² and is occupied by another school and a sports courtyard for a youth center, leaving around 4000 m² for the proposed school. It is a uniform piece of land situated in a residential area and is adjacent to another MoE owned school, Al Abdalieh Mixed Basic School. Also, there is a sports field adjacent to the empty plot. The plot is slightly higher than one of the streets which is located to the south and not directly adjacent to the plot and has a gentle slope.

A house which is adjacent to the plot has slightly trespassed on the land, however the Directorate of Sahab has obtained a signed letter from the owner agreeing that the trespassing part will be removed once the project is planned. Further details will be verified when topographic survey will be conducted and findings will be conveyed to MoE for further action, if necessary.

Overall, no informal land use patterns take place on the land; therefore, the site is suitable for construction activities with no direct impacts on land use.

5.1.3. Noise and Vibrations

Most of the project area experiences 'typical' noise and vibration levels which are generated from normal human activities and motor vehicles. Noise and vibrations from the industrial area are considered to be low given the small amount of industrial activities present.

Road traffic noise levels are considered significantly below 75 to 80 dB (A), the range of densely travelled roads as established by WHO (1999) are representative for urban city areas.

Considering the planned school construction and further development of the surrounding residential area some noise and/or vibrations are generated by the construction works itself. But, the scale of noise and vibrations is limited to the direct neighbourhood of the construction site(s) and of temporary character.

Unfortunately, no qualitative and/or quantitative data indicating the noise and/or vibration potential are available.

5.1.4. Water Resources

Surface Water Resources

Based on information provided by WAJ, the potable water to Sahab area is supplied through two water systems. In the first system, chlorinated water is pumped from Al Muntazah reservoir to feed the new second Abu Alanada reservoir (100,000 m³); in addition, chlorinated water is pumped from Madaba Bridge reservoir to feed the new first Abu Alanda reservoir (50,000 m³) and then pumped to feed the new second Abu Alanda reservoir. Water from the new second Abu Alanda reservoir feeds Sahab reservoir that supplies Sahab area, as shown in **Figure 5-2**. The water in the second system is supplied through 7 wells that feed into Mowaqqar Pumping station reservoir (500 m³) after treatment in an aeration vessel. For disinfection, Chlorine is injected into the reservoir before supplying water to Sahab area as illustrated in Figure 5-3.

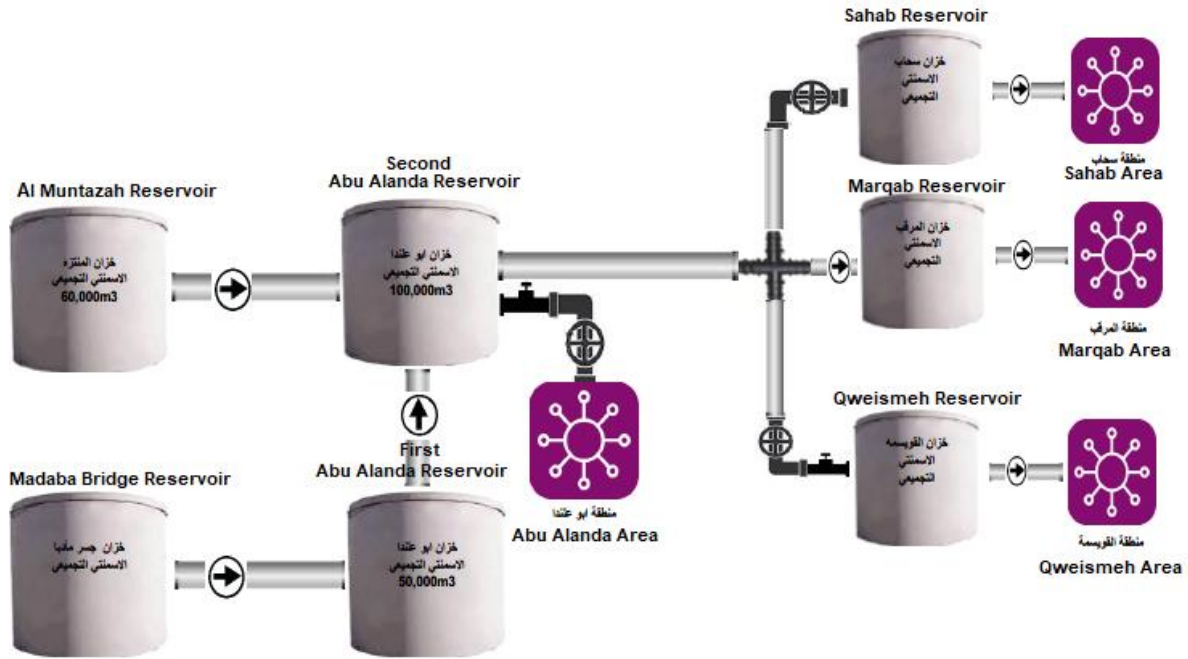

Figure 5-2: Schematic of Water Supply in Sahab – System One

Source: WAJ (2019): Water Supply Document

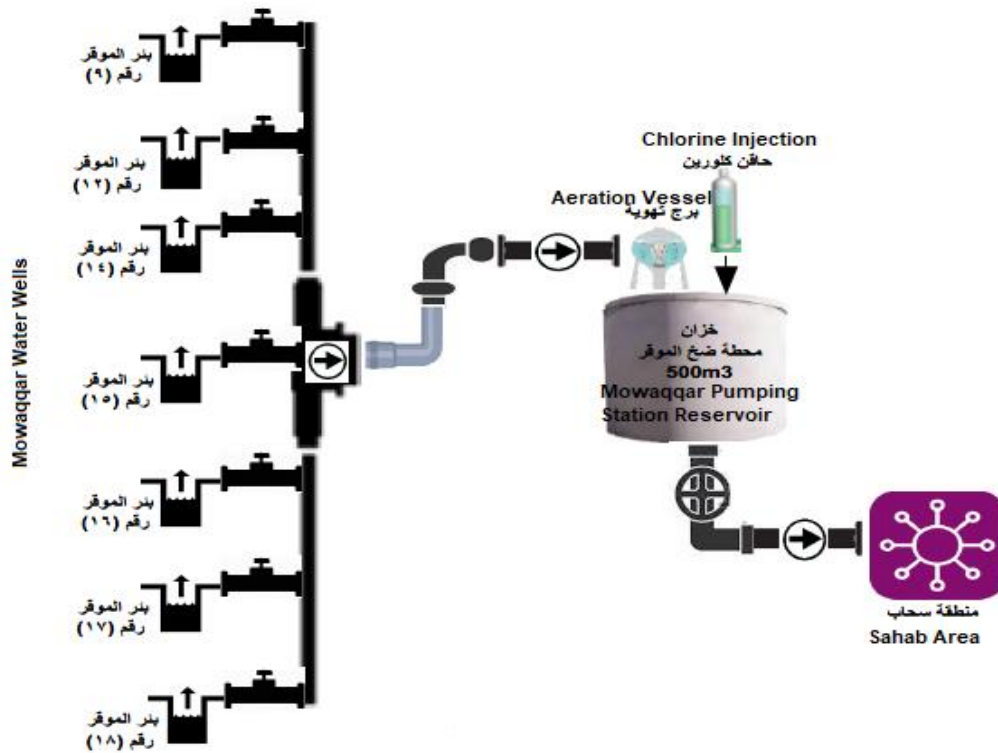

Figure 5-3: Schematic of Water Supply in Sahab – System Two

Source: WAJ (2019): Water Supply Document

Moreover, the surface water basins within Amman Governorate include Azraq Basin, Mujib Basin, Sirhan Basin, Southern Side Wadis Basin, Zarqa Basin and Dead Sea Basin. The main features of these basins are outlined in the table below.

Surface Water Basin	Catchment Area (km ²)	Base Flow (million m ³ per year)	Total Flow (million m ³ per year)
Azraq Basin	12,400	-	22.47
Mujib Basin	6,727	31.38	65.00
Southern Side Wadis	736	25.18	33.11
Zarqa Basin	3,739	43.00	68.30
Sirhan Basin	15,733	-	7.49
Dead Sea Basin	1,508	33.63	39.71

Table 5-1: Main Features of Surface Water Basins

Source: The Study on Water Resources Management in the Hashemite Kingdom of Jordan – JICA

The project is located within the boundaries of Zarqa Surface water Basin. The following Figure 5-4 presents a general overview of the surface water basins in Jordan.

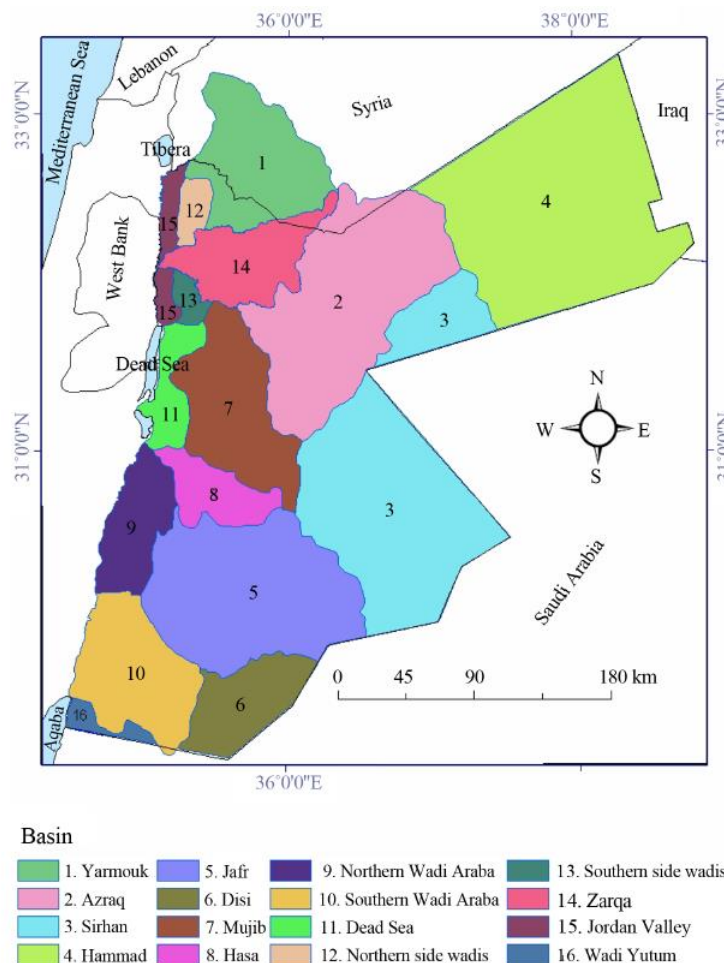

Figure 5-4: Surface Water Basins in Jordan

Source: Al-Ansari et al. (2014): Water Demand Management in Jordan. – Engineering 2014 (6)

Groundwater Resources

Regarding groundwater sources, the Governorate of Amman includes mainly five groundwater basins including Dead Sea, Azraq, North Jordan Valley, Zarqa and Sirhan Basins.

The actual and safe yields of renewable groundwater for the mentioned basins are shown in table below.

Ground Water Basin	Actual Yield (million cubic meters)	Safe Yield (million cubic meters)
Dead Sea Basin	83.85	57
Azraq Basin	69.66	24
North Jordan Valley	45.6	15
Zarqa Basin	164.98	87.5
Sirhan Basin	0	5

Table 5-2: Safe and Actual Yields for Ground Water Basins in Jordan

Source: MWI (2017): Water Sector Facts and Number

Figure 5-4 provides an overview of the groundwater basins in Jordan. The Project site falls within the boundaries of the Azraq Groundwater Basin.

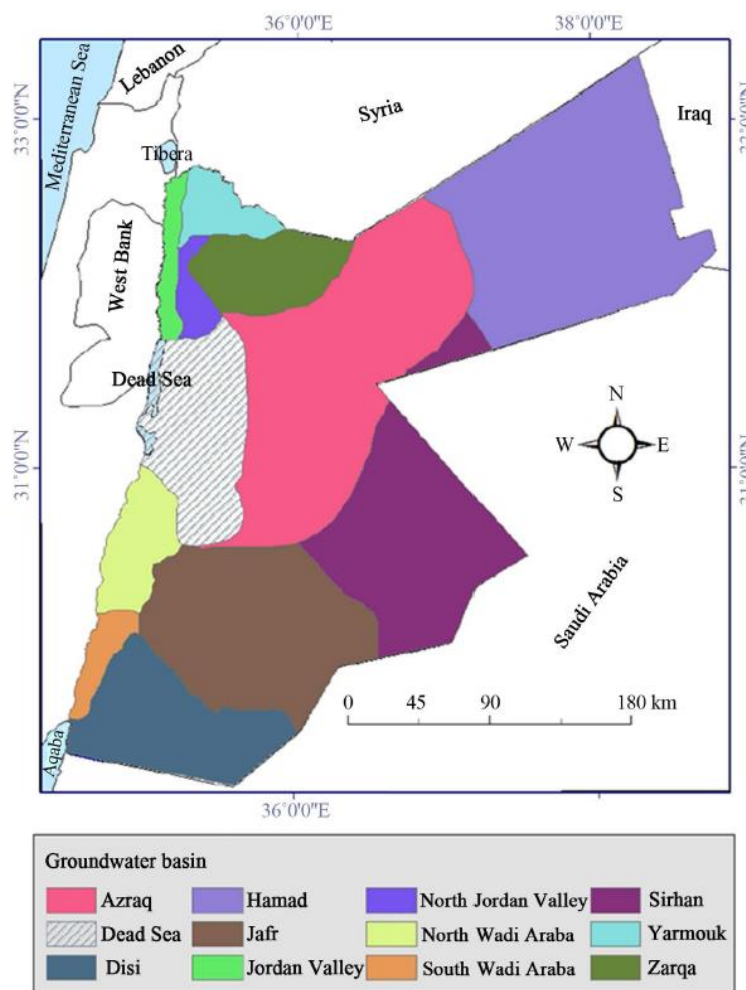

Figure 5-5: Groundwater Basins in Jordan

Source: Al-Ansari et al. (2014): Water Demand Management in Jordan. – Engineering 2014 (6).

5.1.5. Air Quality

In general air quality is influenced by anthropogenic activities distinguishing two main sources, namely mobile and stationary sources. Industrial activities are a major source of ambient air pollution arising from stationary sources while motor vehicles account for the majority of the air pollution emissions from mobile sources.

The majority of industries in Amman Governorate are located in Mowqqar, Qastal and Sahab areas. In Sahab, most industries are concentrated around 3 km south of the proposed site. Emissions to the ambient air from industries include particulate matter (PM), Carbon monoxide (CO), Carbon dioxide (CO₂), Nitrous oxide (NO_x) as well as Sulphur oxide (SO_x). Prolonged exposure to these activities may pose the risk of acute respiratory infections.

Similarly, the main pollutants from exhaust emissions from motor vehicles include Hydrocarbon and Benzopyrene, Phosphorus, Carbon monoxide, Sulphur oxides and Nitrous oxide. Exhaust emissions are highest in urban center and along the major highways and varies according to periods of peak traffic flow.

These conditions described before are not representative for the proposed school area, due to the fact that industries are located 3 km south of the proposed site while the prevailing wind direction is western winds as well as the fact that traffic flows concentrate along main roads.

5.1.6. Road Access & Traffic

The plot is located in a residential area and is accessible through one main road; the land allocated for the school construction is not directly accessed by any roads, however according to the land plan provided by Greater Amman Municipality, there is a planned road south of the proposed site near the school edge. Discussions with municipality will be done to extend it to reach the eastern road. Thus, constructive action has to be taken allowing the safe access to both schools.

Figure 5-6 below indicates the roads that are governmentally owned, shown in red, which ultimately allows the MoPWH to request construction works for paving such roads with no land acquisition process.



Figure 5-6: Road Access to School Site No. 25 Hai Al Sharqi Secondary Mixed School

Source: Greater Amman Municipality, GAM, 2019



Figure 5-7: Aerial View Showing Empty Part of the Plot and Roads

Due to the previously described characteristics the area witnesses heavy traffic. In order to serve as suitable site for a school construction, the road network must be carefully assessed to specify the most suitable traffic management plan that includes safe access for the Civil Defence Department (CDD), sufficient road width, capacity of roads for children and parents bus drop off avoiding congestions and dangerous situations.

5.2. Socio-Economic Environment

5.2.1. Catchment Area

The land is situated in a residential area and is shared with an existing school called Al Abdalieh Basic Mixed School. The school was built through the Saudi Fund and is relatively new. Additional to the migration of refugees, the catchment area has witnessed migration from private to public schools which requires providing new places. The total percentage of Syrians in schools of catchment area is around 4.9%.

There are five schools in the catchment area; only one is within a 1 km radius and it is not overcrowded. Three of the schools are overcrowded, two are mixed schools and one is a basic boys' school, thus building a basic mixed school instead of a secondary mixed school would solve all problems of overcrowding in girls' school and ease the pressure off the basic boys' school.

In this regard, and as proposed in the Site Selection Report (SSR) – Volume 5, the Consultant recommended constructing a basic mixed school of 13 classrooms with a capacity ranging from 468 to 520 in addition to 2 kindergarten classes with a total of 50 students taking into consideration plans for future expansion. Figure 5-8 below present the details of the schools located within the catchment area, while Figure 5-9 presents their location on the map in respect to School Site No. 25 Hai Al Sharqi Secondary Mixed School.

Needs Assessment in Same Gender Schools of Catchment Area 25- Hai Al Sharqi Secondary Mixed School														
No.	National ID No.	School Name	Owned / Rented	1st Shift / 2nd Shift	Gender	No. Class-rooms	Avg. Area of Class-room (m ²)	Capacity of Classrooms (Class Area/ 1.2 m ²)	Current Avg. No. of Students / Class	Total No. of Students	Total No. of Syrian Students	School Capacity (class capacity *no. classrooms)	Notes	Located Within 1km
1	114320	Al- Abdalia Basic Mixed School	Owned	1	F/M	13	35	29	29	375	7	379	Not overcrowded (379-375= 4 available spaces)	Located Within 1km
2	110444	Arwa Bint Abd Al Motaleb Basic Mixed School	Owned	1	F/M	15	25	21	42	626	52	313	Overcrowded (626-313=314)	Not Located Within 1km
3	113492	Al- Abdalia Secondary Mixed School	Owned	1	F/M	20	40	33	38	750	20	667	Overcrowded (750-667=83)	Not Located Within 1km
Total in second shift										0	0			
Total in rented schools										0	0			
Total in overcrowded										397	72	397		
Total current need (from schools that will be replaced)										397	72	Percentage of Syrians in schools to be replaced	72/397=18.13%	

Spaces to be covered by increasing occupancy in existing schools	4
Actual no. of school places to be created	393

Study of Opposite Gender Schools in Catchment Area (Boys Schools)														
No.	National ID No.	School Name	Owned / Rented	1st Shift / 2nd Shift	Gender	No. Class-rooms	Avg. Area of Class-room (m ²)	Capacity of Classrooms (Class Area/ 1.2 m ²)	Current Avg. No. of Students / Class	Total No. of Students	Total No. of Syrian Students	School Capacity (class capacity *no. classrooms)	Notes	Located Within 1km
4	110360	Al- Abdalia Secondary School for Boys	Owned	1	M	13	48	40	38	500	7	520	Not overcrowded (520-500= 20 available spaces)	Not Located Within 1km
5	113614	Al Emam Al Shaf'iei Basic School for Boys	Owned	1	M	20	25	21	40	801	65	420	Overcrowded (801-420=381)	Not Located Within 1km
Total in rented school + second shift										0	0			
Total in overcrowded										381				
Spaces to be covered by increasing occupancy in existing schools										20				

Total in catchment area schools	3052	151	Percentage of Syrians in catchment area schools	151/3052=4.94%
--	------	-----	---	----------------

■ Rented
■ Second Shift
■ Rented + Second Shift
■ Overcrowded
■ Available Spaces / Same type of School
■ Available Spaces / Different Type of School
✓ Rented / Second shift / Crowded / Underutilized Problem solved
✗ Problem unsolved
✗ Problem partially solved
■ No problem to solve

Proposed Solutions of Catchment Area Problems on Same Gender Schools 25- Hai Al Sharqi Secondary Mixed School													
No.	National ID No.	School Name	Owned / Rented	1st Shift / 2nd Shift	Gender	No. Class-rooms	New Avg. No. of Students / Class	Current Total No. of Students	No. of Moved of Added Students	New Total No. of Students	Notes		
1	114320	Al- Abdalia Basic Mixed School	Owned	1	F/M	13	11	375	+4	13	✓	-4	4 Students Were Added To Reach School Capacity
2	110444	Arwa Bint Abd Al Motaleb Basic Mixed School	Owned	1	F/M	15	13	626	-314	15	✓	+314	314 Students Were Moved
3	113492	Al- Abdalia Secondary Mixed School	Owned	1	F/M	20	17	750	-83	20	✓	+83	83 Students Were Moved
New Estimated No. of Students in Proposed School												393	

*Schools of large sizes will not have extra 15% for projected needs within the next 5 years													
Additional 15% for Projected Needs Within Next 5 Years (if School's Size Allows)*=										59	Total Needed Spaces after	452	

Hai Al Sharqi Secondary Mixed School Size Recommendation													
Grade	KG	1st	2nd	3rd	4th	5th	6th	7th	8th	9th	10th	Total	Total with KG
Gender	Mixed	Mixed	Mixed	Mixed	Girls	Girls	Girls	Girls	Girls	Girls	Girls		
No. of Classrooms	2	2	2	2	1	1	1	1	1	1	1	13	15
Total No. of Students (based on 36)	50	72	72	72	36	36	36	36	36	36	36	468	518
Total No. of Students (based on 40)	50	80	80	80	40	40	40	40	40	40	40	520	570

Results A basic mixed school of 13 classrooms with a capacity ranging from 468 to 520 in addition to 2 KGs to be constructed on-site as it would solve all problems of overcrowdedness in girls schools and ease the pressure off the crowded basic boy's school.

Figure 5-8: Details of Schools Located Within the Catchment Area of the School Site No.25

Source: Consultant School Selection Report (SSR) – Volume 5 Final, March 2020

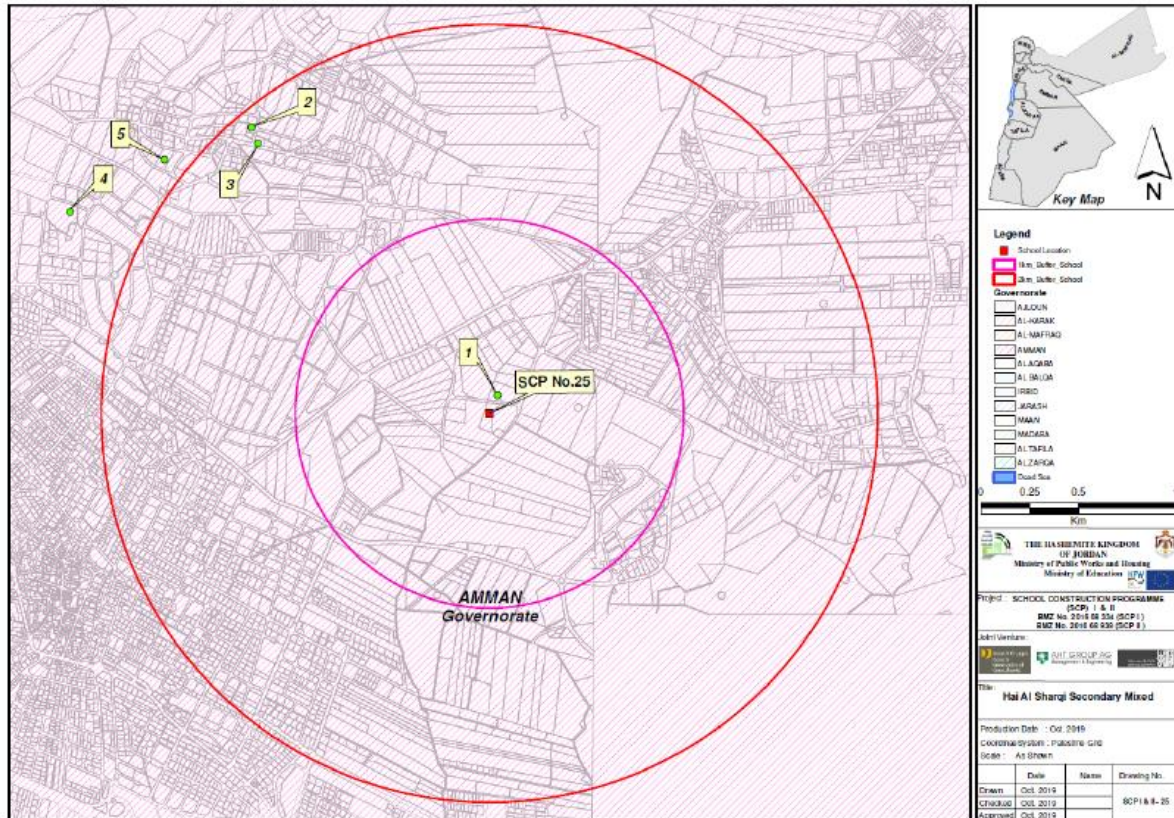

Figure 5-9: Catchment Area of School No.25 Hai Sharqi Secondary Mixed School

Source: Consultant School Selection Report (SSR) – Volume 5 Final, March 2020

5.2.2. Access to Medical, Communal and Religious Services

The closest Mosque is Aisha Um Al Mo'meenen Mosque which is around 800 m of the plot (**Figure 5-10**). The closest medical facility is Khashafiyeh Ad Dabaibeh Primary Health Center located 1.5 km away from the proposed site while the closest hospital is Jameel AlTotangi Hospital and located around 6.5 km away.



Figure 5-10: Location of Closest Mosque to Hai Al Sharqi Site

Source: Google Earth, 2020

5.2.3. Small Scale Business

Typical small scale business such as shops, reseller, cafes, banks, etc. can be found in the vicinity of Hai Al Sharqi site and will not be negatively affected by the school construction activities.

5.2.4. Overview of Demographic Profile

In 2015, and according to the Population and Housing Census, the population of Jordan was estimated to be 9,531,712, with a national population increase of 2.6%. 42% of the Kingdom's population, approximately 4,007,526 are settled in Amman Governorate. Specifically, 169,434 reside in Sahab district in which the proposed project site is located. As reported by the Department of Statistics the population in the district by the end of 2019 was estimated to be 187,330.

The proposed site is located within the Greater Amman Municipality area and specifically in Uhud district. The total population of the greater Amman area is around 4 million, with an annual population increase of 2.4%. Of this population approximately 1% lives in Uhud district. Uhud district consists of nine residential communities or neighbourhoods with a total population of 46,636. The neighbourhood in which the proposed school is located is named Al Abdalieh and it represents the highest population count constituting approximately 52% of Uhud's total population.

Neighbourhood	Male	Female	Total
Al Abdalieh	12,352	10,325	22,677

Table 5-3: Population Statistics of Al Abdalieh Neighbourhood

Source: Department of Statistics (DoS) 2018

The public service sector constitutes the highest percentage of the working population in Sahab, this sector mainly entails working for armed forces, police, and public administration offices. The second highest percentage of the working population in Sahab works in agricultural and grazing activities. Moreover, there is a major industrial city within Sahab, Abdullah II Ibn Al Hussein Industrial Estate (AIE), in which many people are employed.

5.3. Biological Environment

Considering the natural biological environment, the flora / fauna information at the concerned site can be summarized as follows:

- The proposed site is not located in a preserved area.
- No threatened, rare or endangered species of fauna or flora were registered or known to exist around the site.
- No sensitive or fragile habitats were noted in relation to the extent and magnitude of the envisaged works.
- No species of fauna or flora that could be exploited for commercial purposes have noted in proximity to the proposed works.
- The current degree and extent of the proposed works does not interfere with any protected area.
- The closest Important Bird Area (IBA) (Madaba-Hisban IBA) is around 21 km away while the closest Established Reserve (Dibeen Forest Reserve) is around 43 km and the closest grazing reserve (Belaal Grazing Reserve) about 31 km from the proposed site.



Figure 5-11: Location of Proposed Site in Relation to Protected Areas

Source: Google Earth, 2020

6. IMPACT IDENTIFICATION AND ANALYSIS

6.1. Expected Environment and Social Impacts

The implementation of the School Construction Programme / School No. 25 – Hai Al Sharqi Secondary Mixed School is associated with impacts mainly occurring during the construction phase of the Project. Typical negative impacts are related to:

- Health and safety issues including possible dust and noise emissions from any excavations, concrete works and the transportation of soil, waste and other materials affecting the public and the employees of the construction contractor.
- Environmental pollution from the all forms of construction and waste generated when performing the works.

During the operation phase of the Project, limited adverse impacts are anticipated to arise. Typical negative impacts are related to:

- Health and safety issues including maintenance works for the school, traffic issues that might affect the local community and employees of the school.
- Constraints on available utilities including water resources, waste disposal sites, etc.

6.2. Impact Significance Assessment

This type of potential negative impacts during both phases can be effectively controlled, reduced and/or mitigated. Corresponding environmental and social requirements will be integrated in the construction contractor's obligations for daily consideration and monitoring, as well as the operator's obligations towards proper management of the school. Considering the benefits for the concerned community (access to modern school facility; development of future opportunities for children) and the relatively short duration of the works the overall conflict potential is suggested as low.

The overall significance of impacts has been determined by combining the perceived 'Likelihood of occurrence' of the source of the impact in combination with the corresponding impact 'Consequence' describing the severity of the impact, Significance describing the level of required mitigation measures, the Spatial Influence, describes the proximity of the impact, Temporal Influence describes the duration of the impact, and finally Reversibility describes the ability to return to original conditions after implementing mitigation measures. **Table 6-1** below provides the detailed classification of impacts.

Impact Criterion	Effect on Environment	Classification of Effect	
		Expression	Effect description
Likelihood of occurrence	What certainty of occurrence is associated with impact?	Unlikely	Probably will not occur
		Likely	May occur
		Certain	Will occur
Consequence	How severe the impact will be?	Marginal	Little impact
		Critical	Moderate impact
		Severe	High impact
Significance	How important is impact in Project design?	Low	Impact of little importance, needs limited mitigation
		Medium	Impact has influence and requires mitigation
		High	Impact of great importance, mitigation a must

Impact Criterion	Effect on Environment	Classification of Effect	
		Expression	Effect description
Spatial influence	How the impact shall be extended spatially?	Local	Within the site premises
		Regional	Within the surrounding area of the project
		Global	Extends beyond the surrounding area
Temporal influence	How the impact shall extend over time?	Short term	The impact shall last short period of time
		Medium term	The impact shall last medium period of time
		Long Term	The impact shall be permeant
Reversibility	Does the influence of the impact can be removed once the impact end or the influence will remain?	Reversible	The influence of the impact can be reversed
		Irreversible	The influence of the impact cannot be reversed and shall be permanent

Table 6-1: Classification of Impacts

6.3. Proposed Topics to be Scoped Out

With reference to the analysis of the legal and institutional framework (Chapter 3) and collected information in the baseline (Chapter 5) there are certain topics considered of not relevant or with less importance to the project and therefore proposed to be scoped out.

Topics proposed to be scoped out

Given the initial analysis and applicability of the above mentioned standards, ESS 7 and ESS 9 are not applicable based on the following justifications.

- ESS 7 “Indigenous Peoples/Sub-Saharan African Historically Underserved Traditional Local Communities” is not applicable, as there are no such groups or communities within the project site area, nor are such groups affected by the Project.
- ESS 9 “Financial Intermediaries” is not applicable, as there are no FIs involved in this Project.
- KfW Resettlement Policy Framework, as the implementation of the project does not require informal resettlement.

Topics of less importance and therefore proposed to be scoped out

- Surface and groundwater resources as there are no such resources in the vicinity of the project site,
- Biodiversity conservation and sustainable management of living natural resources. Not relevant, given that there are no threatened, rare or endangered species of fauna or flora that were registered or known to exist around the site.
- Climate change assessment (climate check).

6.4. Impact Categorisation

In this Chapter a detailed elaboration of potential impacts associated with the implementation of Hai Al Sharqi Secondary Mixed School project and under consideration of the stakeholder consultation process has been undertaken.

In result, the Project is expected to have no or only minor adverse environmental and social impacts or risks and the implementation and operation does not require any particular protection, compensation or monitoring measures. Identified impacts will mainly occur during the construction phase of the Project and can be effectively mitigated.

Responsive actions (mitigation measures > ESMP > stakeholder involvement) are defined under Chapters 7 and 8.

Table 6-2 and Table 6-3 provides a summary of the potential environmental and socio-economic impacts associated with the project's planned and unplanned activities during the construction phase and operation phase respectively.

No.	Resource Area	Assessment Rationale	Potential Impact(s)	Likelihood	Consequence	Spatial Influence	Temporal Influence	Reversibility	Impact Significance
1	Air Quality and Dust	<ul style="list-style-type: none"> Dust and emission from construction activities and equipment shall affect the work environment within the project site. Dust and emission from moving vehicles on surrounding roads shall affect surrounding residential area. 	Local degradation to air quality due to exhaust emissions.	Very Likely	Marginal	Local	Short term	Reversible	Medium
			Local degradation to air quality due to dust generation from construction activities.	Very Likely	Marginal	Local	Short term	Reversible	Medium
2	Noise	<ul style="list-style-type: none"> Noise from construction activities and equipment shall affect the work environment within the project site. Noise from moving vehicles on surrounding roads shall affect surrounding residential area. 	Noise pollution due to construction activities such as excavation, etc. and use of heavy machineries, vehicle and equipment operation.	Certain	Critical	Local & regional	Short term	Reversible	High
3	Land and Soil	<ul style="list-style-type: none"> Soil disturbance due to excavation and construction works. Soil pollution from construction equipment and construction vehicles within the site. 	Removal of soil due to construction activities, thus causing erosion.	Likely	Marginal	Local	Long Term	Irreversible	Low
			Contamination of soil due to accidental spillage/leakage of chemicals or oils stored on site or used during construction or rupture of fuel storage tanks in construction site.	Likely	Critical	Local	Long Term	Irreversible	Medium
			Local degradation of soil quality due to potential sewage generation.	Likely	Marginal	Local	Long Term	Irreversible	Low
			Local degradation of soil	Unlikely	Marginal	Local	Long	Irreversible	Low

No.	Resource Area	Assessment Rationale	Potential Impact(s)	Likelihood	Consequence	Spatial Influence	Temporal Influence	Reversibility	Impact Significance	
			quality due to wastewater losses such as from concrete mixer.				Term			
4	Water Resources	<ul style="list-style-type: none"> Construction activities will result in the increase of runoff instances during rainfall events. Water demands during construction phase are expected to increase to meet the demands of the additional activities and the demands of workers on site. Given that there are no surface water sources within the proximity of the site, there are no direct impacts on such sources. 	Increased surface water runoff leading to erosion and sedimentation during and after significant rainfall events.	Unlikely	Marginal	Local & Regional	Long Term	Irreversible	Low	
			Increased water demand during construction phase, which might lead to constraints on local users.	Likely	Marginal	Local	Short term	Reversible	Low	
			Contamination of water resources due to overflowing of septic tanks.	Not relevant						
			Local degradation of surface water quality due to accidental spillage/leakage of oil, chemicals or liquid fuels.	Not relevant						
			Surface water pollution due to disposal of construction wastes.	Not relevant						
5	Waste Generation and Disposal	<ul style="list-style-type: none"> Construction activities will result in the increase generation of hazardous & non-hazardous waste. 	Improper management of hazardous and non-hazardous waste generated at site leading to impacts on soil, water and visual environment and health and safety of construction workers and public	Likely	Critical	Local & Regional	Short – Medium term	Reversible	Medium	
6	Aesthetics	<ul style="list-style-type: none"> Due to construction machinery and activities, the local aesthetics will be affected. 	Visual intrusion and aesthetic interference due to potential generation of waste (spoil) and littering in the project area.	Likely	Marginal	Local & Regional	Short term	Reversible	Low	

No.	Resource Area	Assessment Rationale	Potential Impact(s)	Likelihood	Consequence	Spatial Influence	Temporal Influence	Reversibility	Impact Significance
7	Socio-economic Issues	<ul style="list-style-type: none"> The Project is expected to result in short term disturbance to the business-as-usual (BAU) conditions of the local community during the construction phase. Nonetheless, the Project is expected to contribute to improve the access to education in the area, in addition to providing job opportunities. 	Physical and psychological strain to women due to presence of (foreign) workers.	Likely	Marginal	Local & Regional	Short term	Reversible	Low
			Physical and psychological strain to children playing in the vicinity of the construction work and personnel.	Likely	Critical	Local & Regional	Short term	Reversible	Medium
			Emission of dust from construction works which may cause stress to local community and businesses in the area	Unlikely	Marginal	Local & Regional	Short term	Reversible	Medium
			Disturbance of women's wellbeing and social life.	Certain	Positive	Local & Regional	Long term	Irreversible	Positive
8	Community Health and Safety	<ul style="list-style-type: none"> The construction activities may have a temporary impact on the community H&S due to the presence of the machinery. Spread of COVID-19 amongst construction workers 	Impact to public due to dust generation, noise generation, traffic accidents due to road blocks, etc.	Likely	Critical	Local	Short term	Reversible	Medium
			Impact on construction workers as well as the public due to the spread of COVID-19	Likely	Critical	Local	Short – Medium term	Reversible	Medium
9	Occupational Health and Safety	<ul style="list-style-type: none"> The construction activities may increase the risk of the workers' H&S to some extent due to the possibility of injuries and accidents. 	Impact to public due to dust generation, noise generation, traffic accidents due to road blocks, etc. Risk to occupational health and safety from construction activities such as excavation, concrete works, confined space entry,	Likely	Critical	Local	Short term	Reversible	Medium

No.	Resource Area	Assessment Rationale	Potential Impact(s)	Likelihood	Consequence	Spatial Influence	Temporal Influence	Reversibility	Impact Significance
			handling of hazardous materials and chemicals, manoeuvring of construction equipment and machinery, risk of exposure to injuries. Potential accidents from obstructed pedestrian and vehicular access, lack of sufficient signage barricades, warning, lights and other safety precautions that are required by the contractor.						
10	Flora and Fauna	<ul style="list-style-type: none"> Construction activities are expected to disturb the existing ecosystem, in addition to the possible impacts due to improper management of generated waste and its disposal. 	Loss of (protected) terrestrial species		Not relevant, given that there are no threatened, rare or endangered species of fauna or flora were registered or known to exist around the site.				
11	Traffic	<ul style="list-style-type: none"> Construction activities are expected to disturb the existing traffic conditions 	Traffic and road accessibility will be disrupted with the possibility of creating congestions at peak hours.	Likely	Critical	Local & Regional	Short term	Reversible	Medium

Table 6-2: Summary of Environmental and Socio-economic Impacts During Construction Phase

No.	Resource Area	Assessment Rationale	Potential Impact(s)	Likelihood	Consequence	Spatial Influence	Temporal Influence	Reversibility	Impact Significance
1	Land and Soil	Anticipated impacts from improper house-keeping processes.	Improper management of non-hazardous waste generated at the Project site and the local utilities may lead to adverse impacts on the land.	Likely	Critical	Local & Regional	Short – Medium term	Reversible	Medium
		Soil pollution from wastewater leakage	Local degradation of soil quality due to overflowing of septic tanks.	Likely	Marginal	Local	Long Term	Irreversible	Low
2	Water Resources	Increased runoff is expected in the area during rainfall events.	Increased surface water runoff leading to erosion and sedimentation during and after significant rainfall events.	Unlikely	Marginal	Local & Regional	Long Term	Irreversible	Low
		Water demands during operation phase are expected to increase to meet the demands of the additional activities and the demands of workers on site.	Increased water demand during operation phase, which might lead to constraints on local users.	Likely	Marginal	Local	Short term	Reversible	Low
			Contamination of water resources due to overflowing of septic tanks	Not relevant					
3	Waste Generation and Disposal	The amounts of waste generated and disposed during operational phase may increase.	Improper management of non-hazardous waste generated at the	Likely	Critical	Local & Regional	Short – Medium term	Reversible	Medium

No.	Resource Area	Assessment Rationale	Potential Impact(s)	Likelihood	Consequence	Spatial Influence	Temporal Influence	Reversibility	Impact Significance
			Project site and the local utilities may lead to adverse impacts.						
4	Aesthetics	<ul style="list-style-type: none"> Due to presence of the school building, the aesthetics of the local area is altered to some extent 	Visual intrusion and aesthetic interference is considered to be negligible as the site is located in a residential area.	Likely	Marginal	Local & Regional	Long Term	Reversible	Low
5	Socio-economic Issues	<ul style="list-style-type: none"> The Project is expected to result in short term disturbance to the business-as-usual (BAU) conditions of the local community during the operational phase. Nonetheless, the Project is expected to contribute to improve the access to education in the area, in addition to providing job opportunities. 	Potential of increased traffic in the local area due to the operation of the School. Risk for children and parents at bus drop offs due to insufficient road width causing congestions and dangerous situations.	Likely	Critical	Local	Long Term	Reversible	Medium
			Small scale business activities to increase with higher income generation.	Certain	Positive	Local	Long term	Irreversible	Positive
			Workforce employment (men and women).	Certain	Positive	Local & Regional	Long term	Irreversible	Positive
6	Occupational Health and Safety	<ul style="list-style-type: none"> During the operational phase there might be some adverse impacts on workers' H&S. Spread of COVID-19 amongst workers 	Risk to occupational health and safety from maintenance activities.	Likely	Critical	Local	Short term	Reversible	Medium
			Impact on workers as well as the public due to the spread of COVID-19	Likely	Critical	Local	Short Medium term	Reversible	Medium
7	Community Health and	<ul style="list-style-type: none"> Spread of COVID-19 amongst students and 	Impact on school students and staff as	Likely	Critical	Local	Short Medium	Reversible	Medium

No.	Resource Area	Assessment Rationale	Potential Impact(s)	Likelihood	Consequence	Spatial Influence	Temporal Influence	Reversibility	Impact Significance
	Safety	school's staff	well as the public due to the spread of COVID-19				term		
8	Flora and Fauna	<ul style="list-style-type: none"> The activities during the operational phase to disturb the existing ecosystem, in addition to the possible impacts due to improper management of generated waste and its disposal. 	Loss of (protected) terrestrial species.		Not relevant, given that there are no threatened, rare or endangered species of fauna or flora were registered or known to exist around the site.				
9	Traffic Control	<ul style="list-style-type: none"> Daily activities around the school premises would affect traffic and accessibility within the area. Emptying of septic tanks would have an impact on traffic and accessibility in the area 	Traffic and road accessibility will be disrupted with the possibility of creating congestions at peak hours.	Likely	Critical	Local	Short term	Reversible	Medium

Table 6-3: Summary of Environmental and Socio-economic Impacts During Operation Phase

7. ENVIRONMENTAL AND SOCIAL MANAGEMENT PLAN

The Environmental and Social Management Plan (ESMP) identifies measures to address any potential environmental and socio-economic impacts that might occur during the implementation of the School Construction Programme / School No. 25 – Hai Al Sharqi Secondary Mixed School.

Responding to the environmental and socio-economic impacts, detailed mitigation measures have to be identified and evaluated in order to avoid, reduce or remedy the impacts during the construction and operation phase.

The objective of this ESMP is to ensure the integration of environmental and social requirements and proposed mitigation and monitoring measures into the construction contractor's obligations.

The ESMP shall be fully integrated in the construction activities, hereby addressing the responsibilities of the construction contractor (the Contractor), the Engineer and the Employer.

Furthermore, an ESMP has been developed for impacts resulting from the operational phase, which shall be fully integrated in operation activities.

Responding adequately to the complex nature of the envisaged school construction, the ESMP refers to the following issues:

- Environmental and Social Mitigation Measures during Construction,
- Environmental and Social Mitigation Measures during Operation,
- Environmental and Social Quality Monitoring during Construction
- Environmental and Social Quality Monitoring during Operation, and
- Obligations, roles and responsibilities amongst concerned parties.

In the light of the COVID-19 pandemic , KfW Development Bank and the Government of Jordan issued guidance documents on preventing and managing related Environmental, Social, Health and Safety (ESHS) aiming to minimize the risks potentially caused by the virus as introduced under Chapters **Error! Reference source not found.** and **Error! Reference source not found.**. These guiding documents have to be respected by all involved stakeholders; where necessary more detailed actions have to be taken to comply with the imposed requirements.

7.1. Contractors, Engineers and Employer Roles and Responsibilities

Employer's Arrangements

The Employer has the overall responsibility for environmental and social management during the construction phase of the Project. This includes the following responsibilities:

- Ensuring compliance with all relevant national legislation, relevant KfW Sustainability Guideline provisions as well as with the environmental controls and mitigation measures contained in this ESMP.
- Ensure that the design and planning is in compliance with national requirements and aligned with international best practice.
- Supervise and pro-actively monitor the implementation of the Stakeholder Engagement Plan.
- Monitoring the performance of contractors and sub-contractors used for providing workforce, supplies and services.
- Acting as point of contact for consultation and feedback to stakeholders and the public (stakeholder engagement).
- Where possible, the Employer shall facilitate the issuing of the relevant permits, approvals etc. from the relevant authorities. Such assistance shall not however relieve the Contractor of his responsibilities under the contract to obtain such approvals.

Contractor's obligations

The Contractor shall comply with the environmental and social requirements contained in the construction contract. In particular, the Contractor shall:

- Ensure compliance with relevant KfW Sustainability Guideline provisions.
- Ensure environmental awareness among his personnel, suppliers and sub-contractors so that they are fully aware of, and understand these environmental and social requirements.
- Strictly adhere to the provisions of the KfW 'Standard Bidding Document for Procurement of Works' issued in its latest version (currently January 2019), especially provisions with regard to Environmental, Social, Health and Safety (ESHS) related instructions.
- Prior to the commencement of works the Contractor shall submit an Environmental and Social Management Plan (CESMP) for the Engineer's approval indicating how the Contractor will comply with the contract requirements for execution of the works. The CESMP shall be properly implemented by the Contractor during the contract.
- Prior to the commencement of works the Contractor has to nominate the following staff:
 - ESHS Manager
 - Environmental and Social (E&S) Manager
 - Health and Safety (HS) Manager
 - External Stakeholders Relations Manager
 - ESHS Supervisor
 - Community Liaison Officer
- The Contractor has to pro-actively contribute to the implementation of the Stakeholder Engagement Plan. For his workers and all workers of assigned sub-contractors the Contractor has to implement a grievance mechanism.
- Notify the Engineer immediately in the event of any accidental infringements of these environmental requirements to enable appropriate remedial action to be taken immediately by the Contractor.
- Notify the Engineer, at least 7 working days in advance, of any activity it has reason to believe may have significant negative impacts, so that mitigation measures may be implemented in a timely manner.
- The Contractor shall maintain close liaison with utility companies and contractors employed by the other organizations who are carrying out works on or adjacent to the site. The Contractor shall ensure that the progress of the works is not adversely affected by the activities of such other parties and vice versa. The Contractor shall inform the Engineer when the potential disruptions due to the other parties are anticipated.
- Strictly adhere health and safety instructions and guidelines related to COVID-19 pandemic including Guide 12 set by the Government of Jordan and KfW guidelines.

Engineer's Role and Duties

The Engineer will designate all working areas, and monitor and enforce the Contractor's compliance with these environmental and social requirements. In particular, the Engineer will:

- Ensure compliance with relevant KfW Sustainability Guideline provision.
- Strictly adhere to the provisions of the KfW 'Standard Bidding Document for Procurement of Works' issued in its latest version (currently January 2019), especially provisions with regard to ESHS related instructions.
- Strictly adhere to ESHS provisions imposed by the national legal and regulatory framework.

- Enforce and adhere to all health and safety instructions and guidelines related to COVID-19 pandemic issued by the government of Jordan as well as those issued by KfW and ensure proper ESHS monitoring
- Respect provisions of ILO Convention No. 87 (Freedom of Association and Protection of the Right to Organize Convention) and propose mitigation measures allowing full compliance to the Contractor's (including also all sub-contractors) workers and staff.
- Pro-actively manage the implementation of the provisions of the hereafter ESMP.
- Communicate to the Employer, at least 7 working days in advance, any proposed actions which may have negative impacts on the environment.
- Maintain a record of complaints from the public, and communicate these complaints to the Contractor and Employer (grievance mechanism).
- Facilitate communication between all role players in the interest of effective environmental management.

7.2. Environmental and Social Mitigation during Construction & Operation

The mainly short-term negative environmental impacts, which inevitably occur during the construction works, will be minimized by propped planning and application of preventative measures, and will be mitigated by restorative actions after the works are completed as listed in Table 7-1. Additionally, Table 7-2 defines the mitigation measures that shall be implemented during the operational phase to mitigate the anticipated adverse environmental and social impacts.

In practice, proper planning means that environmental and social requirements become an integrative part of the construction contractor's obligations and have to be approved by the supervision engineer and competent authority/ies prior to any construction works.

No.	Aspect	Mitigation measures	Responsibility
Physical Environment			
1	General	<ul style="list-style-type: none"> The provisions listed hereafter shall apply to and be binding upon the Contractor for any part of the works on the site and the subcontractors. The main contractor is responsible to instruct sub-contractors accordingly and to supervise compliance. The Contractor shall ensure that proper and adequate provisions to this end are included in all subcontracts. The Contractor shall employ appropriate construction methods and carry out the works in a manner as to minimize any adverse impacts on environmental and social media listed hereafter within or outside any construction sites during the contract implementation. The Contractor shall submit an Environmental and Social Management Plan (CESMP) for the Engineer's approval indicating how the Contractor will comply with the contract requirements for execution of the works. The CESMP shall be properly implemented by the Contractor during the contract. A grievance mechanism for concerned stakeholders and workers has to be in place. The Contractor shall comply with the KfW Specifications for Project Area Environmental, Social, Health and Safety Management (ESHS). 	Contractor Engineer
2	Air and Dust	<ul style="list-style-type: none"> The Contractor shall use heavy equipment, machinery, and fuels in compliance with national regulations. The Contractor shall perform regular maintenance on all equipment, vehicles and machinery to prevent air emissions. The Contractor shall limit idling of engines when not in use. The Contractor shall make sure that any vehicle or equipment leaving the project area is cleaned of loose debris. Additionally, vehicles and equipment shall be covered to avoid dust generation. The Contractor shall use dust suppression measures on unpaved roads, excavations, stockpiles, and for transport of excavated material to reduce airborne particulates areas and/or sensitive receptors during windy conditions and when needed. The Contractor shall store cement, sand, or other such fine-grained material in manner to prevent wind erosion and dust. Construction vehicles shall comply with speed limits. Speed limits for heavy vehicles within construction site shall be restricted to 20 km/hr. Vehicle and machinery movements during construction shall be restricted to designated routes at all times where practicable. No stockpiling of fine material is allowed within the construction sites. Spillage of materials on roads or pathways shall be cleaned up promptly in accordance with the spill prevention and response plan that shall be developed by the Contractor as part of the CESMP. 	Contractor
3	Noise and Vibration	<ul style="list-style-type: none"> The Contractor shall use heavy equipment, machinery, and fuels in compliance with national regulations. The contractor shall perform regular maintenance on all equipment, vehicle and machinery to prevent noise 	Contractor

No.	Aspect	Mitigation measures	Responsibility
		<p>emissions.</p> <ul style="list-style-type: none"> • The Contractor shall limit idling of engines when not in use to reduce its contribution to noise emissions. • Contractor shall take reasonable measures, such as installing acoustic screens or close barricades, to maintain noise levels within the national requirements at all construction sites. If such measures are not reasonable, the contractor shall try to minimize disruption through other means such as scheduling noisy activity during less sensitive times in consultation with the sensitive receptors or using alternative techniques that create less noise. • Construction activities are prohibited between 8:00pm and 6:00am, according to the 2003 Instruction for Reduction and Prevention of Noise. Moreover, construction activities shall be avoided on Fridays (weekend in residential areas.) • Level of noise must not be higher than 55 dB during day time or 45 dB during night activities (if any). • The Contractor shall provide 24 hours advance notification of construction schedule and activities with potential disturbance to nearest residences and public facilities (i.e. schools, hospitals, mosques etc.) which are abutting to the proposed alignment. • The Contractor shall take responsibility for rectifying damages caused by vibration generated from or by the use of any equipment, machinery, and haulage vehicles. 	
4	Land and Soil	<ul style="list-style-type: none"> • The Contractor shall adopt soil conservation methods during the entire length of the project to reduce the area of destruction during trenching/excavation works. • Upon completion of trenching/excavation works, the Contractor shall restore disturbed areas to their original condition. • Machineries and equipment shall be checked by the Contractor on daily basis to ensure that there is no leak of oil, fuel, greases or other liquids. If leaks are detected, machineries and equipment shall not be operated until repaired. • Contractors shall use impervious drip trays under portable equipment such as mobile generators and pumps to contain any spills or leaks. Contractor shall carry out all re-fuelling in designated areas with impervious surface. Contractor shall ensure no spills of fuel. • All chemicals shall be stored in dedicated areas in tightly closed containers and shall be protected from adverse weather condition. • A spill prevention and response plan shall be prepared by the contractor as part of the CESMP in order to control any inadvertent leakage or spillage. Spill response measures shall be implemented (as necessary) to contain and clean up any contaminated soil. • Any spilled chemical shall be immediately collected and disposed of in accordance with Spill Prevention and Response Plan. • Ensure that constructed septic tanks during construction are well contained and impermeable to prevent leakage of wastewater into soil 	Contractor

No.	Aspect	Mitigation measures	Responsibility
5	Water Resources	<ul style="list-style-type: none"> All chemicals shall be stored in dedicated areas in tightly closed containers and shall be protected from adverse weather condition. A spill prevention and response plan shall be prepared by the Contractor as part of the CESMP in order to control any inadvertent leakage or spillage. Spill response measures shall be implemented (as necessary) to contain and clean up any contaminated soil. Any spilled chemical shall be immediately collected and disposed of in accordance with Spill Prevention and Response Plan. Contractor shall direct contaminated wastewater from washing/maintenance to a drain pit in the construction workshop, collected by a vacuum truck and transported to the nearest approved municipal waste facility. Contractor shall provide workers with and inform them of nearby available sanitation facilities to avoid contamination from any human wastes. 	Contractor
6	Waste Generation and Disposal	<ul style="list-style-type: none"> A dedicated waste management plan shall be developed and implemented based on a minimization approach and high-quality housekeeping practices. The Contractor shall segregate storage for different types of wastes, such as hazardous, non-hazardous recyclable construction material, plastic, paper, etc. to facilitate proper disposal as per waste management plan. If applicable, the Contractor shall provide a separate storage area for hazardous materials. The hazardous materials/products must be labelled with proper identification of its hazardous properties. Chemical waste shall be stored in accordance with the provisions of Material Safety Data Sheets (MSDS). The Contractor shall keep MSDS onsite. The Contractor shall provide trash bins within each construction site so as to prevent littering in the project area and surrounding areas. The Contractor shall establish regular intervals for waste collection and disposal as per waste management plan. Sanitary and organic wastes shall be collected and disposed daily. Inert waste generated from excavation activities shall be recycled to the extent possible, sold to contractors or disposed of to a designated landfill. The Contractor shall provide adequate toilet facilities at the site. Fixed or portable chemical toilets shall be provided wherever needed. Wastewater shall be collected in a septic tank to be installed on site and removed after the completion of construction activities of that specific area. Ensure that septic tanks are emptied and collected by wastewater contractor at appropriate intervals to avoid overflowing. Coordinate with relevant authorities to hire contractor for the collection of wastewater from the site to the closest wastewater treatment plant. 	Contractor
7	Visual and Aesthetic	<ul style="list-style-type: none"> The Contractor shall ensure general cleanliness and good housekeeping practices at construction sites at all times. 	Contractor

No.	Aspect	Mitigation measures	Responsibility
		<ul style="list-style-type: none"> Littering in the project area and surrounding areas shall be prohibited consequently the contractor shall provide trash bins within each construction site so as to prevent littering in the project area and surrounding areas. The Contractor shall progressively rehabilitate disturbed areas; repave streets to the full width after relevant works have been completed. Contractors shall stabilize and plant any disturbed areas. All these activities shall be conducted at the Contractor's own expense. 	
Socio-Economic Environment			
8.	Socio-economic and Social Disturbance	<ul style="list-style-type: none"> The Contractor shall maintain open communications with the local municipality and concerned residents (erect notification boards at construction site providing information about the project and contact numbers). Local residents are to be informed about construction and work schedules, interruption of services and demolition with a 7 days notification in advance. A grievance mechanism for concerned community and individuals has to be in place. Wherever sidewalks or private roads have been removed for purposes of construction, the Contractor shall place suitable temporary sidewalks or roadways promptly and shall maintain them in satisfactory condition Once the construction plan is issued, the Contractor shall hold public meetings to announce construction plan details (time and duration, stages, etc.). Contractor shall demonstrate full commitment to provide safe and easy access to hospitals, mosques, churches (if any), businesses / business owners to their work places whose business may potentially be affected with construction works. If relevant, the Contractor shall ensure that bridges with rails are conveniently placed over trenches especially in front of businesses that require car access into the establishment (gas stations, car maintenance shops, etc.). The Contractor shall obtain work permit from the local authorities to remove or disturb any existing survey markers or other street or roadway markers and are to be restored after work completion. 	Contractor
9.	Community Health and Safety	<ul style="list-style-type: none"> The Contractor shall be responsible for the protection of the public health from any dangers associated with construction activities, and for the safe and easy passage of pedestrians and traffic in areas affected by his activities. The Construction vehicles shall comply with speed limits. Speed limits for heavy vehicles within construction site shall be restricted to 20 km/hr. Ensure that the consultations involve poor households, women, persons with disabilities, the elderly and illiterate persons to ensure the information reaches them and they are aware of the project's specifics before the onset of the project. If relevant, the Contractor shall install fences, barriers, dangerous warning/prohibition signs around the construction area. Traffic control measures shall be implemented including road and canal signs and the use of flag persons to warn of dangerous conditions. The Contractor shall ensure that no children are allowed to be around construction activities in particular during excavation and the installation of structures. 	Contractor

No.	Aspect	Mitigation measures	Responsibility
		<ul style="list-style-type: none"> Necessary measures shall be taken to ensure that the presence and demeanour of construction workers is not sexually or physically threatening women and children under any circumstance. This shall include sensitization of the workers and the community on appropriate behaviours, expectations, and disciplinary actions against workers who do not follow the established protocol. Any excavations, material dumps, or other obstructions likely to cause injury to any person or thing shall be suitably fenced off and at night marked by red warning lights. If relevant, the Contractor shall make available a maintenance crew to repair immediately any water or wastewater pipelines which is broken due to excavation works. The Contractor shall coordinate repair works in close cooperation with the Engineer. The septic tank shall be properly covered and marked. For safety, this cover should not be easily removed. During the emptying of septic tanks, the area should be barricaded to excavation works. The Contractor shall coordinate repair works in close cooperation with the Engineer. Workers should abide by the health and safety instructions and guidelines set by the government of Jordan as well as the guidelines issued by KfW to reduce the risk of COVID-19 outbreak. 	
10.	Occupational Health and Safety	<ul style="list-style-type: none"> The Contractor has to ensure that all workers have access to protective measures, particularly (as a minimum): The Contractor shall comply with the KfW Specifications for Project Area Environmental, Social, Health and Safety Management (ESHS). The Contractor shall nominate a qualified H&S Engineer dedicated for the site. The H&S Engineer and the Contractor shall be responsible for ensuring that a safety plan is prepared and adhered to and shall coordinate with the sub-contractors and or other persons working on or near the site for proper implementation during the execution of the works. Workers shall be briefed regularly on occupational health and safety regulations. The contractor has to provide side security especially when working at height. A grievance mechanism for workers (contractor and sub-contractor) has to be in place. Workers exposure shall be reduced with the use of and proper care of protective clothing and equipment (PPE). The Contractor shall provide sufficient drinking water for workers as well as locations where protection against sun is provided during breaks. Traffic control measures, including road signs and flag persons to warn of dangerous conditions shall be implemented. The Construction vehicles shall comply with speed limits. Speed limits for heavy vehicles within construction site shall be restricted to 20 km/hr. The Contractor shall install fences, barriers, dangerous warning/prohibition signs around the construction area in order to protect the workers. Ground movement shall be controlled and collapsing prevented by systematically shoring, sloping, benching, etc. The Contractor shall develop and implement appropriate fire precautionary measures as per the H&S Plan in 	Contractor

No.	Aspect	Mitigation measures	Responsibility
		<p>accordance with the requirements of the appropriate Local Standards for Construction.</p> <ul style="list-style-type: none"> Contractor must comply with Guide 12 issued by the Ministry of Labour to reduce the risks of COVID-19 spread amongst workers; contractor must also ensure that KfW Info-Sheet on COVID-19 is taken into consideration, especially during the construction phase. 	
11.	Traffic Control	<ul style="list-style-type: none"> The Contractor shall submit a Traffic Management Plan (TMP) taking into consideration current traffic profiles in addition to suitable locations for bypasses, bus stops, drop-offs etc. The Contractor shall comply with all the applicable laws with regard to road safety and transport. The Contractor shall instruct its drivers and equipment operators that vehicles will be expected to comply with all road ordinances, such as speed limits, roadworthiness, load securing and covering. The Contractor's vehicles shall be permitted only within the designated work sites or on existing roads, as would be required to complete their specific tasks. Vehicles are not permitted on re-vegetated areas, and site traffic shall be limited to prevent unnecessary damage to the natural environment. Continuous unobstructed, safe and adequate pedestrian and vehicular access shall be provided to fire hydrants, commercial and industrial establishments, public entities such as mosques, schools, parking lots, service location, police stations and hospitals. If relevant, the Contractor shall arrange with property owners to establish and maintain temporary access roads to various parts of his site as required to complete the works at his own cost. Such roads shall be available for the use of all others performing work or furnishing services in connection with the contract. Existing public access roads used by the Contractor in connection with the execution of the contract shall also be maintained by the Contractor. During the emptying of septic tanks, cones shall be placed on the road; if septic tanks are located on any of the roads, a flagman should be stationed and visible for incoming traffic. 	Contractor
12.	Labour Force Management	<ul style="list-style-type: none"> The Contractor shall ensure continuous compliance to all Labour obligations outlined in the local legislative framework, IFC Performance Standards, and ILO stipulations. The Contractor shall ensure the implementation of a just Human Resource Policy and related procedures and ensure it is communicated clearly to its workforce. The Contractor shall comply and respect workers' rights as per local legislations and other relevant international requirements to cover topics such as wages, compensation, benefits, workers' organization, clear grievance mechanisms, retrenchment, accommodation, etc. The Contractor shall commit to non-discrimination employment procedures with equal opportunities, and prohibit forced and child labour as well as protecting workers including vulnerable groups such as women and migrant workers. 	Contractor
Biological Environment			

No.	Aspect	Mitigation measures	Responsibility
13.	Flora	<ul style="list-style-type: none"> If relevant, clearing of vegetation shall be confined to that necessary for the establishment of required infrastructure and lay down areas. If relevant, trees, shrubs, or other flora on pathways and/or access roads are to be protected by appropriate means. If relevant, removed vegetation shall be replaced at Contractor's own expense by re-planting indigenous species. 	Contractor

Table 7-1: Environmental and Social Mitigation Measures During Construction Phase

No.	Aspect	Mitigation measures	Responsibility
Physical Environment			
1	Air and Dust	<ul style="list-style-type: none"> In case school operation commences before the establishment of a paved access road, proper dust suppression strategies shall be considered to reduce dust generation (watering) To this extent operational water trucks should be available at all times. 	Operator
2	Land and Soil	<ul style="list-style-type: none"> The operator shall ensure that proper waste management practices are implemented to avoid any leakages within the premises of the school. Ensure that constructed septic tanks to be used during operation are well contained and impermeable to prevent leakage of wastewater into soil. 	Operator
3	Water Resources	<ul style="list-style-type: none"> The operator shall ensure sound connection to existing water distribution networks. The operator shall ensure sustainable use of water recourses within the schools' operation and avoid any over consumption. 	Operator
4	Waste Generation and Disposal	<ul style="list-style-type: none"> A dedicated waste management plan shall be developed and implemented based on a minimization approach and high-quality housekeeping practices. The operator shall segregate storage for different types of wastes, such as non-hazardous recyclable material, plastic, paper, etc. to facilitate proper disposal as per waste management plan. The Operator shall establish regular intervals for waste collection and disposal as per waste management plan. Sanitary and organic wastes shall be collected and disposed daily. Ensure that septic tanks are emptied and collected by wastewater contractor at appropriate intervals to avoid overflowing. Coordinate with relevant authorities to hire contractor for the collection of wastewaters from the site to the closest wastewater treatment plant. 	Operator
5	Visual and	<ul style="list-style-type: none"> The Operator shall ensure general cleanliness and good housekeeping practice at school premises at all times. 	Operator

No.	Aspect	Mitigation measures	Responsibility
	Aesthetic	<ul style="list-style-type: none"> As littering in the project area and surrounding areas is prohibited, the Operator shall maintain a housekeeping plan to prevent littering in the school and surrounding areas. The operator shall progressively maintain the school's premises to avoid any adverse impacts to the visual and aesthetics of the area. 	
Socio-Economic Environment			
6	Community Health and Safety	<ul style="list-style-type: none"> School buses shall comply with imposed speed limits. Ensure security measures are in sound conditions around the school to ensure protection of the school children in addition to the local community. Ensure sound traffic control measures are well identified and clearly presented within the vicinity of the school. The septic tank shall be properly covered and marked. For safety, this cover should not be easily removed. During the emptying of septic tanks, the area should be barricaded. Operator must take into account all health and safety precautions and measures issued by KfW as well as the Government of Jordan during the operation phase to reduce the risks of COVID-19 outbreak. 	Operator
7	Traffic Control	<ul style="list-style-type: none"> The operator shall comply with all the applicable laws with regard to road safety and transport, such as speed limits, roadworthiness, and load securing and covering. The operator shall monitor a sufficient road width allowing safe conditions for bus drop off of children and parents. As far as appropriate, a safety system allowing the safe access of the bus drop off has to be considered. During school hours a guidance team has to provide support to children accessing the bus drop off safely. Ensure proper roads for pedestrians and easy access to the School buildings. Discuss impact of traffic increase on unpaved yet roads during school hours; refer also to table 6-2 for mitigation measures and possible additional investment involved. During the emptying of septic tanks, cones shall be placed on the road; if septic tanks are located on any of the roads, a flagman should be stationed and visible for incoming traffic. 	Operator
Biological Environment			
8	Flora	<ul style="list-style-type: none"> Implement proper means and methods of waste management and disposal to limit the impact on local flora and fauna. If relevant, trees, shrubs, or other flora on pathways and/or access roads are to be protected by appropriate means. If relevant, removed vegetation shall be replaced by re-planting indigenous species. 	Operator

Table 7-2: Environmental and Social Mitigation Measures During Operation Phase

7.3. Environmental and Social Monitoring during Construction & Operation

The previous section outlines mitigation measures to ensure that adverse effects during project implementation are avoided. In order to ensure that these mitigation measures are effective and properly implemented, the following monitoring plan shall be implemented and maintained. This chapter discusses the environmental and social performance monitoring that shall be undertaken to evaluate efficiency of mitigation measures and provide a feedback about the actual environmental and social impacts from construction activities.

Monitoring also will ensure compliance with environmental and social standards and will facilitate any required changes and improvements. The monitoring requirements are discussed for each environmental and social aspect during construction and operation phases in Table 7-3 and Table 7-4 respectively.

Aspect	Monitoring	Frequency	Sampling locations	Method	Responsibility	Reporting	Oversight	Performance Indicator
Physical Environment								
Air and Dust	Emissions from vehicles and equipment	Daily	At construction site (emission source)	Source emission monitoring	Contractor	Contractor shall prepare and submit monthly report to Engineer who will in turn communicate to the Employer	Engineer	<ul style="list-style-type: none"> Compliance with Jordanian ambient air quality Standards JS 1140/2006. Complete records of monitoring activities. Regular vehicle maintenance records. No visible dust plumes originating from construction sites. No irregular exhaust (heavy black or white smoke) from equipment and vehicles.
	Dust generated from construction activities, construction vehicle movement, stockpiles, storage of construction materials, etc.			Visual monitoring				
Noise and Vibration	Noise monitoring at 1.5 m above ground. A third person or entity can perform noise monitoring in the case of non-availability of noise meter with the	Noise monitoring at designated spots	At construction site on demand at critical locations (emission source)	Noise monitoring using portable noise meters	Contractor	Contractor shall prepare and submit weekly report to Engineer who will in turn communicate to the Employer	Engineer	<ul style="list-style-type: none"> Compliance with Noise Instructions (2003) Complete records of monitoring activities.

Aspect	Monitoring	Frequency	Sampling locations	Method	Responsibility	Reporting	Oversight	Performance Indicator
	contractor.							
Land and Soil	Visual inspection of disturbed area in and around construction site for erosion.	Daily	At construction site	Visual monitoring	Contractor	Immediate reporting to Engineer in case of accidental spillage. All unplanned incidents/accidents must be recorded as part of CESMP implementation.	Engineer	<ul style="list-style-type: none"> Up-to-date and complete records as required by spill prevention and response procedures. Training records of personnel on spill prevention and response procedures.
	Visual inspection of waste storage area, chemical storage area and fuel storage area for spills and leaks		At construction site in waste storage area, chemical storage area and fuel storage area					
	Visual inspection of vehicles, machinery and equipment for leaks of oils, grease, etc.		At construction site and vehicle parking area					
Water Resources	Visual inspection of any erosion from construction area and transport of sediments and contaminants (e.g. oil, grease).	On demand, run-off after heavy rainfall events	Construction site (trenches, sloped areas)	Visual monitoring	Contractor	Contractor shall prepare and submit monthly report to Engineer who will in turn communicate it to the Employer	Engineer	<ul style="list-style-type: none"> Runoff from constructions site should be clear of heavy particulates, oils/chemicals, or trash. Up-to-date and complete records as required by spill prevention and response

Aspect	Monitoring	Frequency	Sampling locations	Method	Responsibility	Reporting	Oversight	Performance Indicator
								procedures. • Number of spills or incidents as recorded during on-site inspections • Training records of personnel trained in emergency response/spill prevention and response procedures.
	Check all wastewater (that might be collected from trenches and manholes during construction) are diverted to drain pit and disposed of appropriately.	Daily	Construction site (trenches, sloped areas)	Visual monitoring	Contractor	Contractor shall prepare and submit monthly report to Engineer who will in turn communicate to the Employer	Engineer	• Complete records of wastewater disposals (volume to be transferred to next appropriate site)
Waste Generation and Disposal	Site clean and proper storage and handling of (hazardous) waste and sewage.	Daily	At construction sites	Visual monitoring	Contractor	Contractor shall prepare and submit monthly report to Engineer who will in turn communicate to the Employer	Engineer	• Compliance with waste management plan. • Current and complete records

Aspect	Monitoring	Frequency	Sampling locations	Method	Responsibility	Reporting	Oversight	Performance Indicator
	<p>Segregated waste disposal or storage areas are clearly marked.</p> <p>Toilet facilities are readily available near the construction site for all workers.</p>							<p>of regular waste collection and disposal.</p> <ul style="list-style-type: none"> • Records of workers attending follow-up health and safety training on monthly basis. • Compliance with applicable regulations including: <ul style="list-style-type: none"> - Regulation of Solid Waste Management No. 27 of the year 2005 - Regulation of Harmful and Hazardous Waste Management, Transfer and Handling No. 24, 2005 - Instructions for Recycling and Handling of Consumed Oils of the year 2003

Aspect	Monitoring	Frequency	Sampling locations	Method	Responsibility	Reporting	Oversight	Performance Indicator
Visual and Aesthetics	Visual inspection of general cleanliness at site, rehabilitation of damaged roads and waste management	Daily	At construction sites	Visual Monitoring	Contractor	Contractor shall prepare and submit monthly report to Engineer who will in turn communicate to the Employer	Engineer	<ul style="list-style-type: none"> Construction areas are properly restored to original conditions. No construction materials or wastes are present after construction is completed.
Socio-economic Environment								
Socio-economic & Social Disturbance	Monitor health, safety and security requirements are considered and respected	Monthly	At construction site and surrounding community	Visual monitoring, meetings with community leaders	Contractor Community leader	Contractor shall prepare and submit monthly report to Engineer who will in turn communicate to the Employer	Engineer	<ul style="list-style-type: none"> No identified non compliances of health and safety procedures. Review of grievance register
Occupational Health and Safety	Visual inspection of compliance with health and safety procedures	Daily	At construction sites	Visual	Contractor	Contractor shall prepare and submit monthly report to Engineer who will in turn communicate to the Employer.	Engineer	<ul style="list-style-type: none"> No identified non compliances of health and safety procedures. Injuries or accidents to workers/personnel on site are reported and investigated promptly and in compliance with the health and safety procedures.

Aspect	Monitoring	Frequency	Sampling locations	Method	Responsibility	Reporting	Oversight	Performance Indicator
	Monitor working conditions: <ul style="list-style-type: none"> H&S training provided Use of personal protective equipment for workers Accessibility of workers to grievance mechanism 	Monthly Random site inspection Monthly		Check training records Visual Grievance mechanism in place and grievances recorded	Contractor Employer Contractor Contractor Employer		Engineer Engineer Engineer	<ul style="list-style-type: none"> Regular training records of personnel on health & safety procedures on site. H&S training provided PPE used on site by workers Review of grievance register
	Regular controls and testing by the competent health authorities	Random Inspections	At Construction sites	Health inspections and test	Ministry of Health	Immediate reporting to health authorities in case of any symptoms. All medical tests must be recorded. Contractor shall keep track of all workers on site at any day.	Engineer and Ministry of Health	<ul style="list-style-type: none"> No positive COVID-19 cases
Community Health and Safety	Monitor health, safety and security requirements are considered and respected	Monthly	At surrounding community	On-site visits and communication; interviews with, community leaders	Contractor Community leader	Contractor shall prepare and submit monthly report to Engineer who will in turn communicate to the Employer	Engineer	<ul style="list-style-type: none"> No identified non compliances of health and safety procedures. Regular training records of

Aspect	Monitoring	Frequency	Sampling locations	Method	Responsibility	Reporting	Oversight	Performance Indicator
	Ad hoc intervention in case any of the workers show symptoms of a COVID-19 infection	When necessary	At construction sites and in surrounding communities	As per government's recommendations	Contractor Employer	Immediate reporting to health authorities in case of any symptoms. All medical tests must be recorded. Contractor shall keep track of all workers on site at any day.	Engineer and Ministry of Health	<ul style="list-style-type: none"> personnel on health & safety procedures on site. Review of grievance register Minimal rate of infection with positive COVID-19
Traffic Control	<p>Monitor road condition and signage and traffic calming needs.</p> <p>Monitoring access of residents to own properties and public entities.</p>	Daily	At construction site	Visual spot check and inspection	Contractor	Contractor shall prepare and submit monthly report to Engineer who will in turn communicate to the Employer.	Engineer	<ul style="list-style-type: none"> All signage maintained and available at all times Pedestrians and property owners are able to access public entities, business and private homes as expected. All accidents between construction vehicles and private vehicles are reported and investigated

Aspect	Monitoring	Frequency	Sampling locations	Method	Responsibility	Reporting	Oversight	Performance Indicator
								promptly and in compliance with health and safety procedures. <ul style="list-style-type: none"> Accidents and incidents are reported and investigated promptly.
Labour Force Management	Inspect the completeness and comprehensive HR Policy	Quarterly	At construction site	Inspection	Contractor	Contractor shall prepare and submit monthly report to Engineer who will in turn communicate to the Employer.	Engineer	<ul style="list-style-type: none"> Sound employment processes Proper implementation of Grievance mechanisms Implementation of a fair salary scale No discrimination, forced, or child labour
Biological Environment								
Flora	Trees, shrubs on pathways and/or access roads are protected	Random site inspection	At construction sites	Inspection	Contractor	Contractor shall prepare and submit monthly report to Engineer who will in turn communicate to the Employer.	Engineer	<ul style="list-style-type: none"> Revegetation completed Review of grievance register

Table 7-3: Environmental and Social Monitoring During Construction

Aspect	Monitoring	Frequency	Sampling locations	Method	Responsibility	Reporting	Oversight	Performance Indicator
Physical Environment								
Air and dust	Dust emissions from unpaved roads	Daily	Along unpaved access roads	Visual monitoring	Operator	Reporting Employer	Employer	<ul style="list-style-type: none"> No visible dust plumes originating from vehicle moving along unpaved roads.
Land and Soil	Visual inspection of waste storage area, chemical storage area and fuel storage area for spills and leaks.	Daily	At school premises in waste storage area, chemical storage area and fuel storage area	Visual monitoring	Operator	Immediate reporting to Employer in case of accidental spillage.	Employer	<ul style="list-style-type: none"> Up-to-date and complete records as required by spill prevention and response procedures. Training records of personnel on spill prevention and response procedures.
	Visual inspection of vehicles, machinery and equipment for leaks of oils, grease, etc.		At school premises and vehicle parking area					
Water Resources	Ensure sound connection to distribution network by coordinating with the responsible water utility.	Once, prior to operation activities	At school premises	Official communication	Operator	Reporting to Employer.	Employer	<ul style="list-style-type: none"> Up-to-date and complete records of water supply and water bills.
Waste Generation and Disposal	Inspection of implementation of waste management plan and housekeeping practices	Daily	At school premises	Visual monitoring	Operator	Reporting to Employer.	Employer	<ul style="list-style-type: none"> Up-to-date and complete records as required by spill prevention and response procedures. Training

Aspect	Monitoring	Frequency	Sampling locations	Method	Responsibility	Reporting	Oversight	Performance Indicator
								records of personnel on spill prevention and response procedures.
Socio-economic Environment								
Socio-economic and Social Disturbance	Inspection of sound implementation of grievance mechanism	Monthly	At school premises	Official communication	Operator	Reporting to Employer.	Employer	<ul style="list-style-type: none"> Up-to-date and complete records of responses to received grievances
Community Health and Safety	Inspection of effective security measures within school premises	Weekly	At school premises	Official communication & Visual monitoring	Operator	Reporting to Employer.	Employer	<ul style="list-style-type: none"> Up-to-date and complete records of security monitoring and responses.
	Ad hoc intervention in case any of the students/staff show symptoms of a COVID-19 infection	When necessary	At school premises and in surrounding communities	As per government's recommendations	Operator	Immediate reporting to health authorities in case of any symptoms. All medical tests must be recorded. Operator shall keep track of all workers at the school in any day.	Employer and Ministry of Health	<ul style="list-style-type: none"> Minimal rate of infection with positive COVID-19
Occupational Health and Safety	Inspection of Personal Protective Equipment (PPE)	Monthly	At school premises	Official communication & Visual monitoring	Operator	Reporting to Employer.	Employer	<ul style="list-style-type: none"> Up-to-date and complete records of PPEs and

Aspect	Monitoring	Frequency	Sampling locations	Method	Responsibility	Reporting	Oversight	Performance Indicator
								records of any incidences and appropriate responses.
	Regular controls and testing by the competent health authorities	Random Inspections	At school premises	Health inspections and test	Ministry of Health	Immediate reporting to health authorities in case of any symptoms. All medical tests must be recorded.	Employer and Ministry of Health	<ul style="list-style-type: none"> No positive COVID-19 cases
Traffic Control	Inspection of traffic conditions, safe drop off zones	Daily	At school premises	Official communication & Visual monitoring	Operator	Reporting to Employer.	Employer	<ul style="list-style-type: none"> Up-to-date and complete records of traffic control issues and records of any incidences and appropriate responses.

Table 7-4: Environmental and Social Monitoring During Operation

8. STAKEHOLDER ENGAGEMENT PLAN

The Consultant has prepared an initial Stakeholder Engagement Plan (SEP) providing information on the different stakeholders involved in the project. The central purpose of the SEP is allowing the public to participate in and follow up all activities under the project.

Reference is made to Chapter 4.2 preliminary documenting the concerned stakeholders.

Meaningful stakeholder engagement during the construction phase of the project ensures that the school construction can be conducted with the least disruption to local stakeholders and that all realistic expectations regarding a project's commitments and conditions are met. In turn, minimising disruption and meeting expectations are likely to ensure stakeholder factors do not affect project execution through delay and/or interference.

The engagement processes to be followed during construction should be planned and documented during the planning and/or design stage, leading to more certain, less resource-intensive process for all involved stakeholders. Stakeholder engagement is primarily a day-to-day activity of the construction contractor(s) assisted by the Engineer and the Employer.

Upon award, the Contractor shall replace this proposed SEP Framework with his own comprehensive SEP, that should include immediate responses for specific issues.

8.1. Grievance Mechanism for the Concerned Public

In general, the concerned public is mainly positive to the investment as it will lead to continuously improved educational services both with view to the number of available class rooms, but also the quality of the equipment. Nevertheless, in case of complaints or concerns a clear mechanism should be in place in order to address this grievance properly.

The stakeholder grievance structure is mainly an administrative matter, providing a frame for handling of grievances. The mechanism to be implemented is the construction contractor's public face, hence it is essential that company staff sees the grievance mechanism as a service they provide to the concerned public.

Considering that most grievances are raised on short term basis it is therefore essential that clear communication lines to the contractors grievance mechanism exist and that these are communicated to the general public.

In this context a grievance procedure specific to the project (here the individual construction contracts) will be developed with the following aims:

- To build and maintain trust with all stakeholders,
- To prevent adverse consequences of failure to adequately address grievances; and
- To identify and manage stakeholder concerns and thus support effective risk management.

Grievance Procedure

The Grievance Procedure will be free, open and accessible to all and comments and grievances will be addressed in a fair and transparent manner. Information about the procedures, who to contact and how, will be made available.

In particular all workers will be informed of the grievance process and new workers will be informed when they join the project. The grievance procedure comprises the following steps:

1. **Identification of grievance:** Stakeholders shall be able to use the following methods to submit a grievance:
 - Oral by directly contacting the Contractor's Liaison Officer, by phone or SMS;
 - By filling the grievance form; and
 - In writing via the grievance box located at the Contractor's and/or the Engineer's site office.

It is essential that the complaint structure is designed for the customer's convenience, thus should not require difficult administrative procedures. In general, the grievance registration should entail:

- How the complaint was raised (phone, in person, via the grievance form, in writing etc.)?
 - Who issues the complaint?
 - What the complaint is about?
 - Date and location?
 - Who received the complaint at the company?
2. **Grievance is formally acknowledged** through a personal meeting, phone call, or letter as appropriate, within 2 working days of submission. If the grievance is not well understood or if additional information is required, clarification should be sought from the complainant during this step.
3. **Handling of the complaint:** The Contractor's Liaison Manager delegates the complaint internally in writing to the relevant staff/personnel for development of an appropriate response. If required, the grievance may be send for consideration of the senior management. The Contractor's Liaison Manager will address the following issues:
- How the complaint should be prioritised?
 - Who in the company and external (e.g. public, Engineer, Employer) must be informed?
 - Who in the company is responsible for dealing with the complaint?
 - Minimum requirements in communication with the complainer (call, visit, follow-up) of the responsible officer at the company.
 - Timeframes and quick response procedures.
 - Forms (computerised) to be filled in by company staff.

Beyond the information channels described before, the Contractor shall provide information on designated contact points and staff/site information boards along with corresponding information on further progress on works.

4. **A response** is developed by the delegated team and Contractor's Liaison Manager with input from the Senior Management (if required) and others, as necessary.
- The response to a grievance will be provided 1 week days after receipt of the grievance.
- Should the need arise; the Contractor will consider the establishment of a conflict resolution committee (involvement of contractor, Engineer, Employer, local authorities, complainant etc.) for the management of complex grievance issues.
5. **Required actions are implemented** to deal with the issue, and completion of these is recorded on the grievance documentation.
- The response of the complainant is recorded to help assess whether the grievance is closed or whether further action is needed. The Contractor's Liaison Manager should use appropriate communication channels, most likely telephone or face to face meeting, to confirm whether the complainant has understood and is satisfied with the response. The complainants' response should be recorded in the grievance documentation.
- If actions taken on a grievance are not successful, a stakeholder may turn to court in accordance with the existing legislation of Jordan.
6. **Further actions** require the documentation of all individual complaints in the regular monthly reporting to the Engineer and Employer. Corresponding information records shall be also provided by the Employer to the international financing agency (here KfW) at quarterly basis.

An exemplary grievance mechanism procedure is illustrated in Figure 8-1.

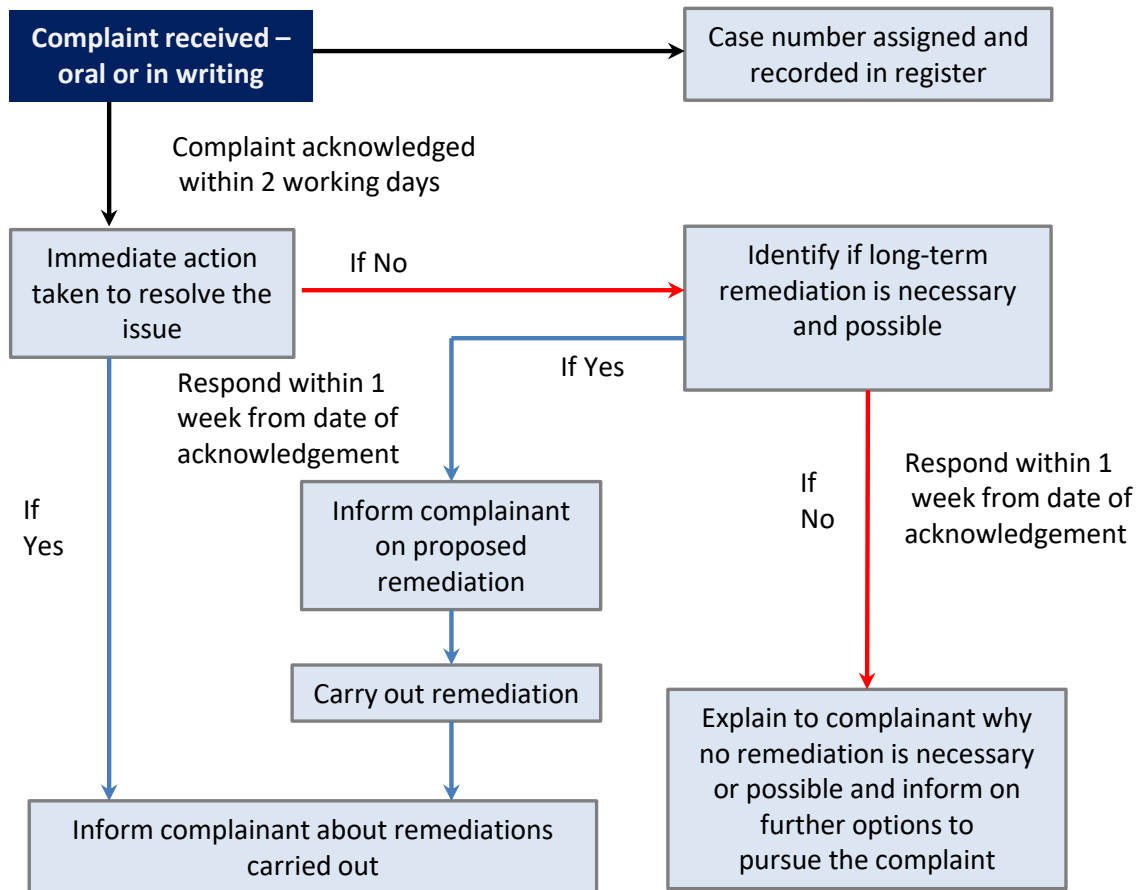

Figure 8-1: Proposed Grievance Mechanism Procedure

8.2. Grievance Mechanism for Workers

It is important that workers are treated fairly and receive prompt responses to problems and concerns. Otherwise, grievances may take the form of collective disputes when they are not resolved. Also, they will then lower the morale and efficiency of the employees. Unattended grievances result in frustration, dissatisfaction, low productivity, and lack of interest in work.

Grievance may result from the following factors:

- Improper working conditions such as strict production standards, unsafe workplace, bad relation with managers, etc.,
- Irrational management policies such as overtime, transfers, demotions, inappropriate salary structure, etc., and/or
- Violation of organizational rules and practices.

Grievance procedures provide a clear and transparent framework to deal with difficulties that may arise as part of their working relationship from a worker's perspective. It is important that workers have a course of action available, should they have a complaint. Procedures are necessary to ensure that everybody is treated in the same way in similar circumstances and to ensure issues are dealt with fairly, reasonably and in a timely manner.

There is no prescribed form for grievance mechanisms but there are guiding principles that should underpin them as introduced hereafter:

1. **Quick action:** As soon as the grievance arises, it should be identified and resolved. Training must be given to responsible staff to effectively and timely manage a grievance. This will lower the detrimental effects of grievance on the employees and their performance.

2. **Acknowledging grievance:** The managing staff must acknowledge the grievance put forward by the worker as manifestation of true and real feelings of the employees. Acknowledgement by the manager implies that the manager is eager to look into the complaint impartially and without any bias. This will create a conducive work environment with instances of grievance reduced.
3. **Gathering facts:** The managing staff should gather appropriate and sufficient facts explaining the grievance's nature. A record of such facts must be maintained so that these can be used in later stage of grievance redressal.
4. **Examining the causes of grievance:** The actual cause of grievance should be identified. Accordingly, remedial actions should be taken to prevent repetition of the grievance.
5. **Decision Making:** After identifying the causes of grievance, alternative course of actions should be thought of to manage the grievance. The effect of each course of action on the existing and future management policies and procedure should be analysed and accordingly decision should be taken by the managing staff.
6. **Execution and review:** The managing staff should execute the decision quickly, ignoring the fact, that it may or may not hurt the employees concerned. After implementing the decision, a follow-up must be there to ensure that the grievance has been resolved completely and adequately

In order to guarantee a quick and effective way of providing a grievance the construction contractors should install secret post boxes at selected places allowing workers the anonymous provision of their cases.

8.3. Monitoring of Stakeholder Engagement Plan

Up to the present, there is no structured approach at the Employer's site to the SEP. Therefore, in order to avoid lack of ownership the SEP monitoring need to be addressed and harmonised among Contractor, Engineer and Employer.

Monitoring is important for the SEP and can be done in different ways. The Consultant proposes a monitoring that is on a continuous basis. The SEP must be a vivid instrument at the hands of the Employer and relevant for the objective to achieve, hence it must be strategic, but also flexible.

It is therefore proposed that the responsible Engineer's staff assisted by the Contractor's staff reports at internal meetings with the Employer's focal point on the progress of SEP implementation. Meeting formats should be developed addressing the following issues:

- To whom have we communicated with (and about what)?
- Did we get the results we expected with the communication?
- If No – why not and what can we change? (Consequently, adaptation of the SEP will be required).
- If Yes – how can we show that we achieved the results (gather 'evidence' of results – indicators are, inter alia, such evidence).

The half-yearly progress report should analyse (in general):

- How the project has developed (activities and budget)?
- What has the project achieved (results – short and medium term)?
- How the context of the project has developed? (Here an analysis of stakeholders is important and the progress/setbacks related to the SEP).

For the half-yearly progress report, it would be advantageous to have a workshop with a group of representative staff of the Contractor(s), Engineer(s) and selected stakeholders (residents and business representatives) in order to develop lessons learnt and support actions considering the strategic SEP purpose.

Annex 1: Official Letter of MoEnv regarding EIA procedures



٢٥٣٤٠ ٧ / ١٠٠ / ٣
الرقم ٢٠١٩٠٠٦٠١٦
التاريخ
الموافق

Handwritten signature

Dorsch International Consultants GmbH

**Subject: School Construction Programme
Official letter from Ministry of Environment**

Dear Madam / Sir,

With reference to Ministry of Environment official letter No. 4/7/4680 dated 29/05/2019
Enclosed herewithin.

Kindly note that the above mentioned official letter from Ministry of Environment states that: "this project does not require any Environmental Impact Assessment with reference to by law No 37 for the year 2005".

Yours sincerely

Minister of Public Works and Housing

Eng. Falah Abdullah Al-Omsh

الأمين العام
المهندس عمار غرايبة

- CC: H.E. Minister Public Works & Housing.
- CC: Minister of Planning & International Cooperation.
- CC: H.E. Minister of Education and Minister of Higher Education and Scientific Research
- CC: H.E. Secretary General of Ministry of Public Works and Housing
- CC: Dorsch International Consultants GmbH, Munchen, Germany with Dar Al Omran, Jordan & AHT Group AG, Essen, Germany.
- CC: KFW Office Amman/phone: 5854378/ Fax: 5854573
- CC: Director of Technical Affairs of Building Studies.
- CC: Director of Building Studies.
- CC: Eng Rula AlTamimi.
- Attachment: Ministry of Environment official letter No. 4/7/4680 dated 29/05/2019

Handwritten note: م. رولا التميمي

الملكية الأردنية الهاشمية

مقاطعة: ٢٥٨-٣٨٠٣ فاكس: +٩٦٢ ٦٥٨٧٥٩٠ ص.ب: ١٢٢٠ عمان ١١١١٨ الأردن . البريد الإلكتروني: mpwh@mpwh.gov.jo

Annex 2: Initial Environmental Examination (IEE) Protocols

Date: 11th March 2020: S. AlHamarneh, L. Mansour

Site: Hai Sharqi Secondary School

Community Representatives: -

Contact Details: -





PS 1: Assessment and Management of Environmental and Social Risks and Impacts	Yes	No
Plot of land of a uniform shape?	✘	
Steep slope on site? <i>Gentle slope towards the street</i>	✘	
If there is a slope, is it towards the street / a natural wadi? (for easy drainage)	✘	
Site higher than surrounding streets?	✘	
Nearby disposal or waste collection area?		✘
Heavy traffic in the area?		✘
Access and dispersal roads nearby? <i>The plot allocated for the school is not served directly by any roads</i>		✘
On a major street and / or intersection?		✘
Dusty / lower air quality?		✘
Likelihood of natural disasters to occur?		✘
Access to medical / communal / religious services? <i>The closest Mosque is Aisha Um Al Mo'meenen Mosque which is around 800 m of the plot. The closest medical facility is Khashafiyeh Ad Dabaibeh Primary Health Center located 1.5 km away from the proposed site. Jameel AlTotangi Hospital is located around 6.5 km away. Site is served with water supply and electricity but not a sewage network.</i>	✘	
Presence of buildings that are not structurally fit as educational buildings?		✘
Proximity to natural water resources (surface water, groundwater)?		✘
Proximity of socio-economic activities (i.e. shops, salons, day-care centres... etc.) <i>Shops, restaurants, banks are located around 2 km away from the proposed location</i>	✘	



PS 2: Labour & Working Conditions	Yes	No
Is the area a residential area?	<input checked="" type="checkbox"/>	<input type="checkbox"/>
Is the area an industrial area?	<input type="checkbox"/>	<input checked="" type="checkbox"/>
Is the site on agricultural land?	<input type="checkbox"/>	<input checked="" type="checkbox"/>

PS 3: Resource Efficiency & Pollution Prevention	Yes	No
Does the site show indications of pollution?	<input type="checkbox"/>	<input checked="" type="checkbox"/>
Close to high decibel noise sources?	<input type="checkbox"/>	<input checked="" type="checkbox"/>
Are there any solid waste accumulation, chemical residuals etc.?	<input type="checkbox"/>	<input checked="" type="checkbox"/>
Are there other construction or industrial activities in the surrounding area?	<input type="checkbox"/>	<input checked="" type="checkbox"/>

PS 4: Community Health, Safety, & Security	Yes	No
Does the site have a potential impact on the community's health, safety, & security of the surrounding community? <i>During construction of the proposed school site nearby residents will be affected by regular construction related impacts such as noise and dust. Effective mitigation has to be planned.</i>	<input checked="" type="checkbox"/>	<input type="checkbox"/>
Have access to medical services? <i>The closest medical facility is Khashafiyeh Ad Dabaibeh Primary Health Center located 1.5 km away from the proposed site. Jameel AlTotangi Hospital is located around 6.5 km away</i>	<input checked="" type="checkbox"/>	<input type="checkbox"/>
Nearby water utilities available?	<input checked="" type="checkbox"/>	<input type="checkbox"/>
Electricity services available?	<input checked="" type="checkbox"/>	<input type="checkbox"/>
Any ethical conflicts due to presence of refugees?	<input type="checkbox"/>	<input checked="" type="checkbox"/>

PS 5: Land Acquisition & Involuntary Resettlement	Yes	No
Is the site occupied?	<input type="checkbox"/>	<input checked="" type="checkbox"/>
Are there Bedouins or tribal nomads on site?	<input type="checkbox"/>	<input checked="" type="checkbox"/>
Do the Bedouins or tribal nomads settle in the area depending on the season?	<input type="checkbox"/>	<input checked="" type="checkbox"/>

PS 6: Biodiversity Conservation and Sustainable Management of Living Natural Resources	Yes	No
Is the site part of a protected area?		
Is a lot of natural vegetation present?		
Would terrestrial species be potentially affected?		
Would aquatic species be potentially affected?		

PS 7: Indigenous People	Yes	No
Are any indigenous people living on the site?		
Are any indigenous people living nearby the site?		

PS 8: Cultural Heritage	Yes	No
Are there any archaeological remains in the area?		

Notes & Comments > site visit dated 30th January 2020

- In terms of E&S relevant factors (physical, socio-economic, biological) the visual site inspection has shown no or insignificant conflict potential.
- Potential negative impacts to nearby residents during the construction phase of the school can be effectively mitigated.
- Any business activities are concentrated along the main road and will not be negatively affected by the school construction.
- The site is not served by a sewage network.
- The access to site is not served by paved roads. However, there is a planned road which ends near the school edge. Discussions with municipality will be done to extend it to reach the eastern road
- The plot is shared with an existing basic mixed school and a sports field.

Conclusion: The proposed site can be considered as having no or minor impacts in accordance with the KfW Sustainability Guideline.

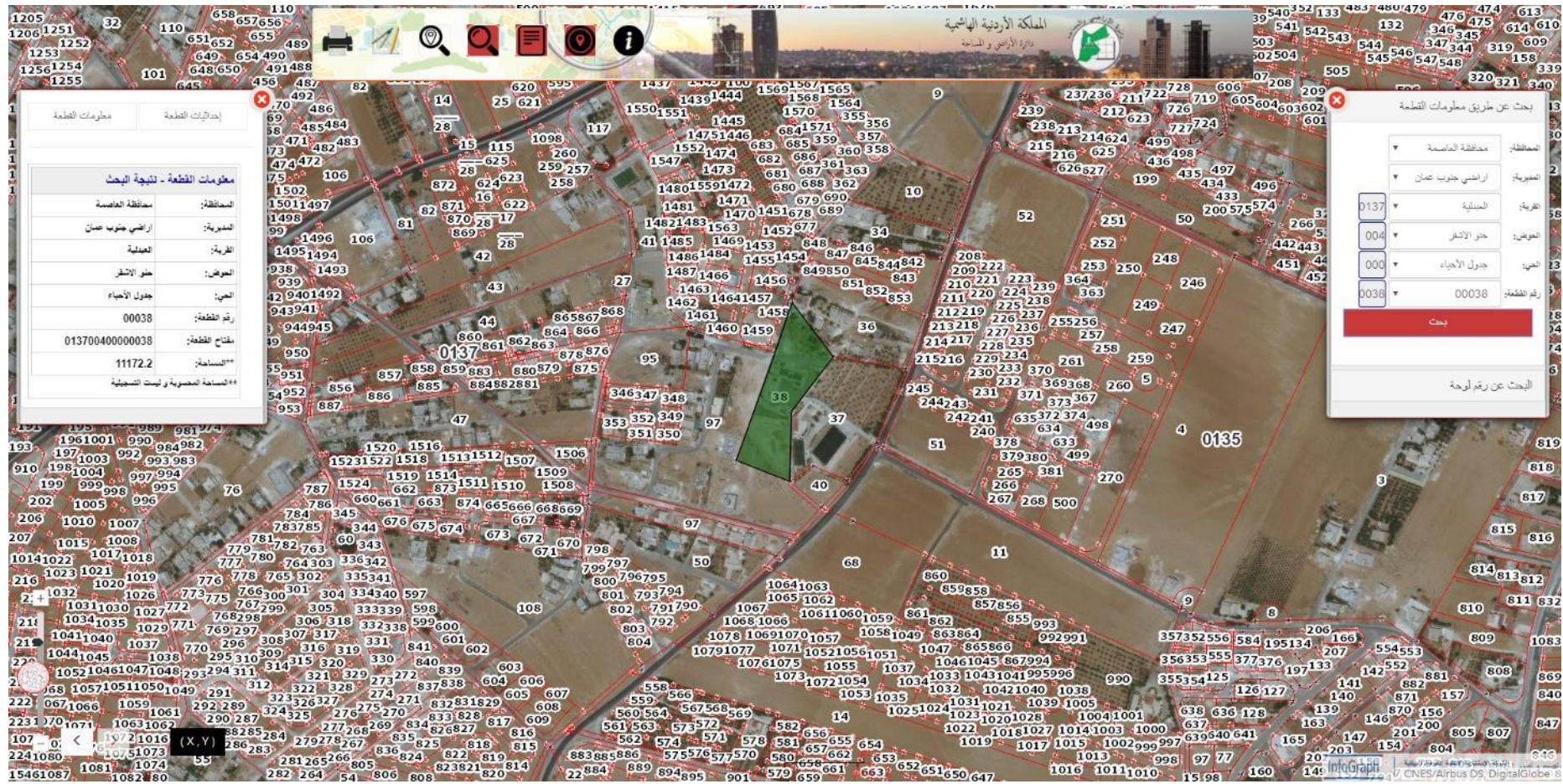

Figure: Location Map Hai Al Sharqi

Annex 3: Public Consultation Protocol

School Site	Hai Al Sharqi Secondary Mixed School
Method	Virtual Zoom Consultations
Date	8 December 2020 // 10:00 – 12:00
Contact Person	Dr. Khitam Al Sawarees MoE – Educational Development Council

Overall Brief

- The Consultant Team has organized a virtual local consultation session with the support of the Educational Development Council (MoE) Dr. Khitam Al Sawarees on Tuesday, 8 December 2020, to present the findings of the Environmental and Social Impact Assessment (ESIA) study as well as the results of the Environmental and Social Management Plan (ESMP), the main objectives of the School Construction Program, and general details of the proposed new school.
- The audience included representatives of the local community, heads of the various decentralized units in the area as well as educational development departments.
- The main outcome of the session was very positive, whereby the local community strongly supported the construction of the new school, given the extensive need of new educational buildings in the area.

Agenda of Local Consultation Session

10:00 – 10:05	Welcoming Note by Educational Development Council
10:05 – 10:30	Presentation of Project / ESIA Findings and Outcomes
10:30 – 11:45	Discussion and Questionnaire
11:45 – 12:00	Closure of Session

List of Attendees

No.	Name	Position
1	Tayseer Al Jarabaa	City Council
2	Hamad Al Kouz	Local Community member
3	Ali Raggad	Educational Development
4	Abu Anas Al Kouz	Local Community member
5	Raed Aqel	Local Community member
6	Khitam Al Sawaries	MoE – Educational Development Council
7	Salam Najjar	Consultant – Senior Programme Manager
8	Saba' AlHamarnah	Consultant- Environmental Engineer
9	Lubna Mansour	Consultant – Junior Architect

Topics of the Presentation

- Project Background
- Project Site Selection Process
- Elements of proposed new school including classrooms, students, impact on existing school
- Classification and identification of E&S impacts
- E&S Management and Monitoring Plan

Major Points of Discussion (Q&A Session)

Comments with Reference to the ESIA

- The attendees were supportive of the Program and the construction of additional schools in their area and noted that there is a big need for more boys schools in the area.
- The attendees stressed that they fully encourage the project and offered their support to those working on the project.
- The attendees do not expect any challenges will face the project, however, they requested that the construction and handover take place as soon as possible.
- Given the location of the proposed site, the attendees had no objection from an environmental or social perspective to construct a school on the proposed boundaries.

Additional Comments

- With regards to the questionnaire, the attendees did not foresee any major negative impacts for the project and supported the idea that a school in the area will have many benefits. Nonetheless, they marked the impacts due to erosion and potential spread of COVID-19 pandemic as important whilst all other impacts were not important or neutral. The Consultant responded that such potential impacts are mainly limited to the construction phase of the school and can be effectively reduced or mitigated. Responsive measures are already considered in the ESMP.
- The attendees agreed that this project will provide many employment opportunities and will increase the income for all businesses in the area.
- The Consultant provided the attendees with the phone number and e-mail of the project team to ease communication in case of any grievances, questions and further concerns.

Annex 4: Public Consultation Questionnaire

Questionnaire Template

Personal Information

1. Name of Respondent.....
2. Level of Education attained:
Not attended any school.....Primary.....Secondary.....
Graduate.....Post Graduate.....
3. Main Occupation.....
4. Contacts: Tel.....E-mail.....
5. Who do you represent?
 - KfW Development Bank
 - Ministry of Education
 - Ministry of Public Works and Housing
 - Ministry of Environment
 - Ministry of Water and Irrigation
 - Ministry of Agriculture
 - Ministry of Health
 - NEPCO
 - Municipality or Mutessarifat
 - Non-governmental organisation (NGO)
 - Local Community Member
 - Other, please explain.....

General Information on the location

1. Have there been conflicts over this land (Y/N)? If yes when, how were they resolved?.....
.....
.....

2. What Public facilities are there in the area? Hospitals, Place of Worship, Market Centre.....

3. Do you anticipate that the proposed project will affect your use of these facilities or your ease of access to them? Yes/No..... If yes, explain:

Attitude to the project

1. Have you heard about this project before?
 Yes
 No
2. Do you like the idea of a new school in your area and do you agree that a school in the area is much needed?
 Yes
 No

If no, why not?

.....

3. How Important are, in your view, the following environmental and social impacts?

A: Very important

B: Important

C: Neutral

D: Not Important

E: Not Important at all

	A	B	C	D	E
Degradation of air quality during construction (due to dust, construction activity, vehicle movement, etc.)	<input type="checkbox"/>	<input type="checkbox"/>	<input type="checkbox"/>	<input type="checkbox"/>	<input type="checkbox"/>
Noise during construction and operation	<input type="checkbox"/>	<input type="checkbox"/>	<input type="checkbox"/>	<input type="checkbox"/>	<input type="checkbox"/>
Increased traffic flow during construction and operation	<input type="checkbox"/>	<input type="checkbox"/>	<input type="checkbox"/>	<input type="checkbox"/>	<input type="checkbox"/>

Loss of agricultural land	<input type="checkbox"/>	<input type="checkbox"/>	<input type="checkbox"/>	<input type="checkbox"/>	<input type="checkbox"/>
Spread of COVID-19 among workers, local communities and school staff and students	<input type="checkbox"/>	<input type="checkbox"/>	<input type="checkbox"/>	<input type="checkbox"/>	<input type="checkbox"/>
Change of aesthetic due to the presence of construction equipment during construction and the school building during operation	<input type="checkbox"/>	<input type="checkbox"/>	<input type="checkbox"/>	<input type="checkbox"/>	<input type="checkbox"/>
Removal of soil due to construction activities, thus causing erosion.	<input type="checkbox"/>	<input type="checkbox"/>	<input type="checkbox"/>	<input type="checkbox"/>	<input type="checkbox"/>
Contamination of soil due to accidental spillage/leakage of chemicals or oils stored on site	<input type="checkbox"/>	<input type="checkbox"/>	<input type="checkbox"/>	<input type="checkbox"/>	<input type="checkbox"/>
Increased Generation of Waste	<input type="checkbox"/>	<input type="checkbox"/>	<input type="checkbox"/>	<input type="checkbox"/>	<input type="checkbox"/>
Physical and psychological strain to women and children due to the construction work and presence of workers personnel	<input type="checkbox"/>	<input type="checkbox"/>	<input type="checkbox"/>	<input type="checkbox"/>	<input type="checkbox"/>

4. What other impacts do you think this project will have on you?

Positive Impacts	Negative Impacts

5. Do you think the project will have a positive impact with regards to increasing income to small scale businesses (shops, stationary stores, minimarkets /supermarkets)

- Strongly agree
 Agree
 Neutral
 Disagree
 Strongly Disagree

6. In your view, do you think the project will generate employment opportunities for the local community

- Strongly agree Agree Neutral Disagree Strongly Disagree

7. What are your expectations from the project?

.....
.....

8. Which aspects of cultural, sacred and archeological sites might be threatened by the project? Name and exact location

.....

9. What challenges do you think the proposed project will face during construction and operation?

.....
.....

10. What roles and contributions is your community willing to make for the proposed project?

.....
.....

11. Do you have any suggestions for the project team?

.....
.....